



INSTRUCTION MANUAL

VHF MARINE TRANSCEIVER

IC-M423 IC-M424

This device complies with Part 15 of the FCC Rules. Operation is subject to the condition that this device does not cause harmful interference.

Icom Inc.



FOREWORD

Thank you for purchasing this Icom product. The IC-M423/IC-M424 VHF MARINE TRANSCEIVER is designed and built with Icom's state of the art technology and craftsmanship. With proper care, this product should provide you with years of trouble-free operation.

We appreciate you making the IC-M423/IC-M424 your radio of choice, and hope you agree with Icom's philosophy of "technology first." Many hours of research and development went into the design of your IC-M423/IC-M424.

◇ FEATURES

- *Simple operation with large keys*
- *Easy to hear speaker*
- *Built-in DSC meets ITU Class D requirement*
- *Rugged waterproof construction*
- *Optional COMMANDMICIV™ (HM-195)*
- *Easy to make an individual DSC calls using the optional MA-500TR Class B AIS Transponder*

CLEAN THE TRANSCEIVER AND MICROPHONE THOROUGHLY WITH FRESH WATER after exposure to water including salt, otherwise, the keys and switch may become inoperable due to salt crystallization.

IMPORTANT

READ ALL INSTRUCTIONS carefully and completely before using the transceiver.

SAVE THIS INSTRUCTION MANUAL — This instruction manual contains important operating instructions for the IC-M423/IC-M424.

EXPLICIT DEFINITIONS

WORD	DEFINITION
⚠ WARNING!	Personal injury, fire hazard or electric shock may occur.
CAUTION	Equipment damage may occur.
NOTE	If disregarded, inconvenience only. No risk of personal injury, fire or electric shock.

For Canada:

This device complies with RSS-310 of Industry Canada. Operation is subject to the condition that this device does not cause harmful interference.

Cet appareil est conforme au CNR-310 d'Industrie Canada. Son exploitation est autorisée sous réserve que l'appareil ne cause pas de brouillage préjudiciable.

IN CASE OF EMERGENCY

If your vessel requires assistance, contact other vessels and the Coast Guard by sending a Distress call on Channel 16.

USING CHANNEL 16

DISTRESS CALL PROCEDURE

1. "MAYDAY MAYDAY MAYDAY."
2. "THIS IS" (name of vessel).
3. Say your call sign or other description of the vessel (AND 9 digit DSC ID if you have one).
4. "LOCATED AT" (your position).
5. State the nature of the distress and assistance required.
6. Give any other information which might facilitate the rescue.

Or, transmit your Distress call using digital selective calling on Channel 70.

USING DIGITAL SELECTIVE CALLING (Ch 70)

DISTRESS CALL PROCEDURE

1. While lifting up the key cover, hold down [DISTRESS] for 3 seconds until you hear 3 short beeps and then one long beep.
2. Wait for an acknowledgment on Channel 70 from a coast station.
 - After the acknowledgement is received, Channel 16 is automatically selected.
3. Hold down [PTT], then transmit the appropriate information as listed above.

RADIO OPERATOR WARNING



Icom requires the radio operator to meet the FCC Requirements for Radio Frequency Exposure. An omnidirectional antenna with gain not greater than 9 dBi must be mounted a minimum of 5 meters (measured from the lowest point of the antenna) vertically above the main deck and all possible personnel. This is the minimum safe separation distance estimated to meet all RF exposure compliance requirements. This 5 meter distance is based on the FCC Safe Maximum Permissible Exposure (MPE) distance of 3 meters added to the height of an adult (2 meters) and is appropriate for all vessels.

For watercraft without suitable structures, the antenna must be mounted so as to maintain a minimum of 1 meter vertically between the antenna, (measured from the lowest point of the antenna), to the heads of all persons AND all persons must stay outside of the 3 meter MPE radius.

Do not transmit with radio and antenna when persons are within the MPE radius of the antenna, unless such persons (such as driver or radio operator) are shielded from antenna field by a grounded metallic barrier. The MPE Radius is the minimum distance from the antenna axis that person should maintain in order to avoid RF exposure higher than the allowable MPE level set by FCC.

FAILURE TO OBSERVE THESE LIMITS MAY ALLOW THOSE WITHIN THE MPE RADIUS TO EXPERIENCE RF RADIATION ABSORPTION WHICH EXCEEDS THE FCC MAXIMUM PERMISSIBLE EXPOSURE (MPE) LIMIT. IT IS THE RESPONSIBILITY OF THE RADIO OPERATOR TO ENSURE THAT THE MAXIMUM PERMISSIBLE EXPOSURE LIMITS ARE OBSERVED AT ALL TIMES DURING RADIO TRANSMISSION. THE RADIO OPERATOR IS TO ENSURE THAT NO BYSTANDERS COME WITHIN THE RADIUS OF THE MAXIMUM PERMISSIBLE EXPOSURE LIMITS.

Determining MPE Radius

THE MAXIMUM PERMISSIBLE EXPOSURE (MPE) RADIUS HAS BEEN ESTIMATED TO BE A RADIUS OF ABOUT 3M PER OET BULLETIN 65 OF THE FCC. THIS ESTIMATE IS MADE ASSUMING THE MAXIMUM POWER OF THE RADIO AND ANTENNAS WITH A MAXIMUM GAIN OF 9dBi ARE USED FOR A SHIP MOUNTED SYSTEM.

AVERTISSEMENT POUR LES OPÉRATEURS RADIO



AVERTISSEMENT

Icom exige que l'opérateur radio se conforme aux exigences de la FCC en matière d'exposition aux radiofréquences. Une antenne omnidirectionnelle dont le gain ne dépasse pas 9dBi doit être fixée à une distance minimale de 5 mètres (mesurée depuis le point le plus bas de l'antenne) verticalement au-dessus du pont principal et de tout le personnel qui peut s'y trouver. Il s'agit de la distance de sécurité minimale prévue pour satisfaire aux exigences de conformité en matière d'exposition aux RF. Cette distance de 5 mètres est établie en fonction de l'exposition maximale admissible sécuritaire de 3 mètres établie par la FCC, à laquelle on ajoute la hauteur d'un adulte (2 mètres); cette distance convient pour tous les navires.

Dans le cas des embarcations sans structure convenable, l'antenne doit être fixée de façon à maintenir une distance minimale de 1 mètre verticalement entre cette antenne (mesurée depuis son point le plus bas) et la tête de toute personne présente; toutes les personnes présentes doivent se tenir à l'extérieur d'un rayon d'exposition maximale admissible de 3 mètres.

Ne pas émettre à l'aide de la radio et de l'antenne lorsque des personnes se trouvent à l'intérieur du rayon d'exposition maximale admissible de cette antenne, à moins que ces personnes (comme le conducteur ou l'opérateur radio) ne soient protégées du champ de l'antenne par un écran métallique relié à la masse. Le rayon d'exposition maximale admissible équivaut à la distance minimale que cette personne doit maintenir entre elle et l'axe de l'antenne pour éviter une exposition aux RF supérieure au niveau d'exposition maximale admissible fixé par la FCC.

LE NON-RESPECT DE CES LIMITES PEUT CAUSER, POUR LES PERSONNES SITUÉES DANS LE RAYON D'EXPOSITION MAXIMALE ADMISSIBLE, UNE ABSORPTION DE RAYONNEMENT DE RF SUPÉRIEURE À L'EXPOSITION MAXIMALE ADMISSIBLE FIXÉE PAR LA FCC.

L'OPÉRATEUR RADIO EST RESPONSABLE D'ASSURER QUE LES LIMITES D'EXPOSITION MAXIMALE ADMISSIBLE SOIENT RESPECTÉES EN TOUT TEMPS PENDANT LA TRANSMISSION RADIO. L'OPÉRATEUR RADIO DOIT S'ASSURER QU'AUCUNE PERSONNE PRÉSENTE NE SE SITUE À L'INTÉRIEUR DU RAYON D'EXPOSITION MAXIMALE ADMISSIBLE.

**Établir le rayon d'exposition maximale admissible
ON ESTIME QUE LE RAYON D'EXPOSITION MAXIMALE ADMISSIBLE EST D'ENVIRON 3 M, TEL QUE STIPULÉ DANS LE BULLETIN OET 65 DE LA FCC. CETTE DISTANCE ESTIMÉE TIENT COMPTE D'UN SYSTÈME INSTALLÉ SUR UN NAVIRE UTILISANT LA PUISSANCE MAXIMALE DE LA RADIO ET DES ANTENNES DONT LE GAIN MAXIMAL EST DE 9dBi.**

FCC INFORMATION

• **FOR CLASS A UNINTENTIONAL RADIATORS:**

This equipment has been tested and found to comply with the limits for a Class A digital device, pursuant to part 15 of the FCC Rules. These limits are designed to provide reasonable protection against harmful interference when the equipment is operated in a commercial environment. This equipment generates, uses, and can radiate radio frequency energy and, if not installed and used in accordance with the instruction manual, may cause harmful interference to radio communications.

Operation of this equipment in a residential area is likely to cause harmful interference in which case the user will be required to correct the interference at his own expense.

NOTE

A WARNING STICKER is supplied with the U.S.A. version transceiver.

To comply with FCC regulations, this sticker must be affixed in such a location as to be readily seen from the operating controls of the radio as in the diagram below. Make sure the chosen location is clean and dry before applying the sticker.

EXAMPLE



PRECAUTIONS

⚠ WARNING! NEVER connect the transceiver to an AC outlet. This may pose a fire hazard or result in an electric shock.

⚠ WARNING! NEVER connect the transceiver to a power source of more than 16 V DC or use reverse polarity. This will ruin the transceiver.

⚠ WARNING! NEVER cut the DC power cable between the DC plug at the back of the transceiver and fuse holder. If an incorrect connection is made after cutting, the transceiver may be damaged.

CAUTION: NEVER place the transceiver where normal operation of the vessel may be hindered or where it could cause bodily injury.

KEEP the transceiver and microphone at least 1 m away from the vessel's magnetic navigation compass.

DO NOT use or place the transceiver in areas with temperatures below -20°C (-4°F) or above $+60^{\circ}\text{C}$ ($+140^{\circ}\text{F}$) or, in areas subject to direct sunlight, such as the dashboard.

DO NOT use harsh solvents such as benzine or alcohol to clean the transceiver, as they will damage the transceiver's surfaces. If the transceiver becomes dusty or dirty, wipe it clean with a soft, dry cloth.

DO NOT disassemble or modify the transceiver for any reason.

BE CAREFUL! The transceiver rear panel will become hot when operating continuously for long periods of time.

Place the transceiver in a secure place to avoid inadvertent use by children.

BE CAREFUL! The transceiver and the optional HM-195 COMMANDMICIV™ meet IPX7 requirements for waterproof protection. However, once the transceiver has been dropped, waterproof protection cannot be guaranteed because of possible damage to the transceiver's case or the waterproof seal.

* Except for the DC power connector, NMEA In/Out leads and AF Out leads.

For U.S.A. only

CAUTION: Changes or modifications to this device, not expressly approved by Icom Inc., could void your authority to operate this device under FCC regulations.

Icom, Icom Inc. and the Icom logo are registered trademarks of Icom Incorporated (Japan) in Japan, the United States, the United Kingdom, Germany, France, Spain, Russia and/or other countries.

COMMANDMICIV is a registered trademark of Icom Incorporated (Japan) in Japan and the United States.

TABLE OF CONTENTS

FOREWORD	i	■ Adjusting the volume level.....	15
IMPORTANT	i	■ Adjusting the squelch level.....	15
EXPLICIT DEFINITIONS.....	i	■ Adjusting the display backlight level.....	16
IN CASE OF EMERGENCY	ii	■ AquaQuake water draining function	16
RADIO OPERATOR WARNING	iii	5 SCAN OPERATION.....	17-18
AVERTISSEMENT POUR LES OPÉRATEURS RADIO.....	iv	■ Scan types	17
FCC INFORMATION	v	■ Setting Favorite channels.....	18
NOTE.....	v	■ Starting a scan.....	18
PRECAUTIONS.....	vi	6 DUALWATCH/TRI-WATCH.....	19
TABLE OF CONTENTS.....	vii	■ Description	19
1 OPERATING RULES.....	1	■ Operation	19
2 PANEL DESCRIPTION.....	2-7	7 DSC OPERATION	20-71
■ Front panel	2	■ DSC address ID	20
■ Function display	5	■ Position and time programming.....	23
■ Speaker Microphone	7	■ Distress call.....	24
■ Softkey function.....	7	■ Transmitting DSC calls	28
3 PREPARATION.....	8	■ Receiving DSC calls	51
■ MMSI code programming.....	8	■ Received Call log	63
4 BASIC OPERATION.....	9-16	■ Transmitted Call log.....	65
■ Channel selection	9	■ DSC Settings	66
■ Receiving and transmitting.....	11	■ Making an Individual call using an AIS transponder ..	70
■ Call channel programming	13	8 OTHER FUNCTIONS.....	72-74
■ Channel name programming.....	13	■ Intercom operation	72
■ Microphone Lock function	14	■ RX Speaker function	73

■ PA (Public Address) function.....	73
■ Horn function.....	74
9 MENU SCREEN OPERATION	75–82
■ Menu screen operation	75
■ Menu screen items.....	76
■ Radio Settings items	77
■ Configuration items	78
10 CONNECTIONS AND MAINTENANCE	83–89
■ Connections	83
■ Antenna.....	85
■ Fuse replacement	85
■ Cleaning	85
■ Supplied accessories	85
■ Mounting the transceiver.....	86
■ MB-132 installation	87
■ Microphone installation	88
11 SPECIFICATIONS AND OPTIONS	90–91
■ Specifications.....	90
■ Options.....	91
12 CHANNEL LIST.....	92
13 TROUBLESHOOTING.....	93
14 TEMPLATE	94

◇ Priorities

- Read all rules and regulations pertaining to call priorities, and keep an up-to-date copy handy. Safety and distress calls take priority over all others.
- You must monitor Channel 16 when you are not operating on another channel.
- False or fraudulent distress calls are prohibited under law.

◇ Privacy

- Information overheard, but not intended for you, cannot lawfully be used in any way.
- Indecent or profane language is prohibited.

◇ Radio licenses

(1) SHIP STATION LICENSE

You may require a current radio station license before using the transceiver. It is unlawful to operate a ship station which is not licensed, but required to be.

If required, contact your dealer or the appropriate government agency for a Ship-Radiotelephone license application. This government-issued license states the call sign which is your craft's identification for radio purposes.

(2) OPERATOR'S LICENSE

A Restricted Radiotelephone Operator Permit is the license most often held by small vessel radio operators when a radio is not required for safety purposes.

If required, the Restricted Radiotelephone Operator Permit must be posted or kept with the operator. If required, only a licensed radio operator may operate a transceiver.

However, non-licensed individuals may talk over a transceiver if a licensed operator starts, supervises, ends the call and makes the necessary log entries.

A current copy of the applicable government rules and regulations is only required to be on hand for vessels in which a radio telephone is compulsory. However, even if you are not required to have these on hand it is your responsibility to be thoroughly acquainted with all pertinent rules and regulations.

NOTE: Even though the transceiver is capable of operation on VHF marine channels 3, 21, 23, 61, 64, 81, 82 and 83, according to FCC regulations these simplex channels cannot be lawfully used by the general population in USA waters.

■ Front panel

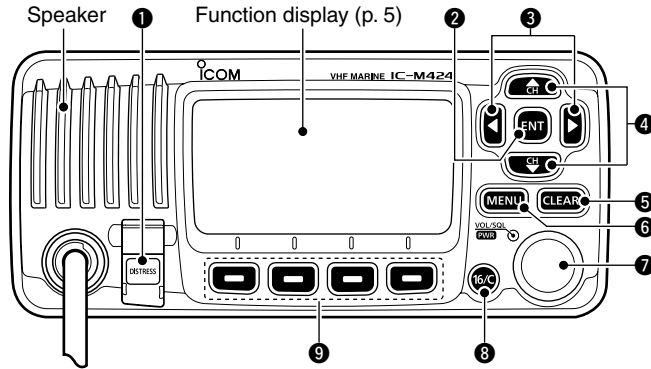

- 1 DISTRESS KEY [DISTRESS]** (pp. 24, 25)
 Hold down for 3 seconds to transmit a Distress call.
- 2 ENTER KEY [ENT]** (pp. 8, 10, 75)
 Push to set the input data, selected item, and so on.
- 3 LEFT AND RIGHT KEYS [◀]/[▶]**
 - Push to switch to the previous or next key function that is assigned to the softkeys. (p. 7)
 - Push to select the desired character or number in the table while in the channel name, position, MMSI code programming mode, and so on. (pp. 8, 13, 23)

- 4 UP AND DOWN/CHANNEL SELECT KEYS [▲•CH]/[▼•CH]**
 - Push to select the operating channels, Menu items, Menu settings, and so on. (pp. 11, 75)
 - While scanning, push to check Favorite channels, change the scanning direction or manually resume a scan. (p. 18)

- 5 CLEAR KEY [CLEAR]** (pp. 8, 13, 75)
 Push to cancel the entered data, or to return to the previous screen.

- 6 MENU KEY [MENU]** (p. 75)
 Push to enter or exit the Menu screen.

- 7 VOLUME AND SQUELCH SWITCH/POWER SWITCH [VOL/SQL•PWR]**
 - When the power is OFF, hold down for 1 second to turn ON power. (p. 11)
 - Hold down for 1 second to turn OFF power.
 - When the power is ON, push to enter the volume level adjustment mode.* (p. 15)
 - Each push of this switch toggles the mode between the volume level adjustment, squelch threshold level adjustment, operating channel selection and the LCD and key backlight brightness adjustment, if assigned.
 - Rotate to adjust the volume level.* (p. 15)

*The desired function can be assigned in the Menu screen.

2 PANEL DESCRIPTION

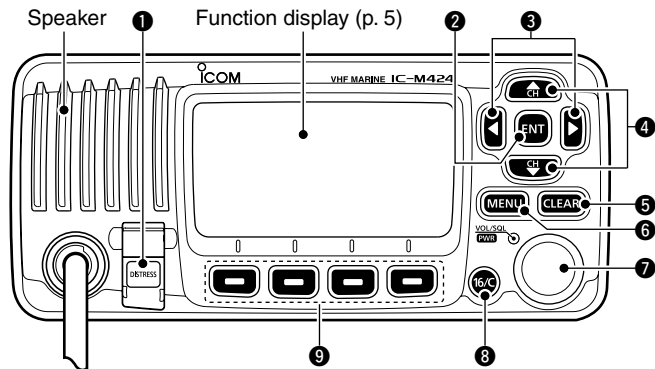

8 CHANNEL 16/CALL CHANNEL KEY [16/C]

- ➔ Push to select Channel 16. (p. 9)
- ➔ Hold down for 1 second to select the Call channel. (p. 9)
 - “CALL” appears when the Call channel is selected.
- ➔ When the Call channel is selected, hold down for 3 seconds to enter Call channel programming mode. (p. 13)

9 SOFTKEYS

Desired functions as described below can be assigned in the Menu screen.

Scan [SCAN] (p. 18)

Push to start or stop a Normal or Priority scan.

Dualwatch/Tri-watch [DW] (p. 19)

- ➔ Push to start a Dualwatch or Tri-watch.
- ➔ Push to stop a Dualwatch or Tri-watch when either is activated.

High/Low [HI/LO] (p. 11)

- Push to set the power to high or low.
- Some channels are set to only low power.

Channel/Weather channel [CH/WX]* (pp. 9, 11)

- Push to select and toggles the regular channel and Weather channel.
- *Only U.S.A. and Australian version transceivers.

Channel [CHAN]* (p. 9)

- Push to select a regular channel.
- *Only Chinese version transceiver.

Public address [PA] (p. 73)

- Push to enter the PA (Public Address) mode.

RX Speaker [RX-SP] (p. 73)

- Push to turn the RX Speaker mode ON or OFF.

Horn [HORN] (p. 74)

- Push to enter the Horn mode.

Intercom [INCM] (p. 72)

- Push to enter the Intercom mode.

AquaQuake [AQUA] (p. 16)

While holding down, the AquaQuake function is activated to clear water away from the speaker grill.

Favorite channel [FVOR] (p. 18)

- ➔ Push to set or clear the displayed channel as a Favorite (Tag) channel.
- ➔ Hold down for 3 seconds to clear or set all Favorite channels in the selected channel group.

Name [NAME] (p. 13)

Push to enter the channel name programming mode.

Backlight [BKLT] (p. 16)

Push to enter the LCD and key backlight brightness adjustment mode.

- While in the adjustment mode, push [▲]/[▼]/[◀]/[▶] or rotate Dial to adjust the brightness of the LCD and key backlight.

LO/DX [LO/DX]* (p. 11)

Push to turn the Attenuator function ON or OFF.

- “LOCAL” appears when the Attenuator function is ON.

*Only U.S.A. and Australian version transceivers.

Log [LOG] (p. 63)

Push to enter “RCVD CALL LOG” in the DSC CALLS menu.

2 PANEL DESCRIPTION

■ Function display

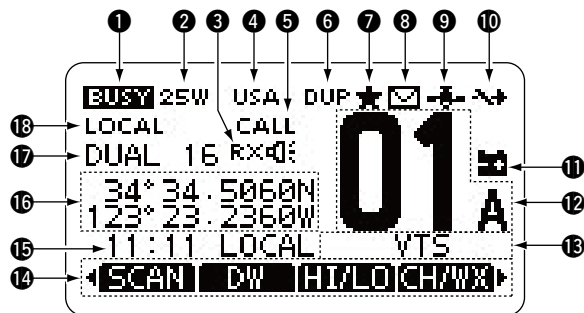

1 BUSY/TRANSMIT ICON (p. 11)

- ➔ “BUSY” appears when receiving a signal or when the squelch is open.
- ➔ “TX” appears while transmitting.

2 POWER ICON (p. 11)

- ➔ “25W” appears when high power is selected.
- ➔ “1W” appears when low power is selected.

3 RX SPEAKER ICON (p. 73)

Appears while in the RX Speaker mode.

4 CHANNEL GROUP ICON (p. 10)

- ➔ A selected channel group icon, U.S.A. “USA,” International “INT” or Canadian “CAN” appears, depending on the transceiver version.
 - ➔ “WX” appears when the weather channel is selected.*
- *Only U.S.A. and Australian version transceivers.

5 CALL CHANNEL ICON (p. 9)

Appears when the Call channel is selected.

6 DUPLEX ICON (p. 10)

Appears when a duplex channel is selected.

7 FAVORITE CHANNEL ICON (p. 18)

Appears when a Favorite (Tag) channel is selected.

8 MESSAGE ICON (p. 63)

Blinks when there is an unread DSC message.

9 GPS ICON

- ➔ Stays ON when the GPS receiver is activated and valid position data is received.
- ➔ Blinks when invalid position data is being received.

10 SWITCH ICON (p. 67)

Appears when the “CH 16 SWITCH” in DSC Settings is set to ‘OFF.’

11 LOW BATTERY ICON

Blinks when the battery voltage drops to approximately 10 V DC or less.

12 CHANNEL NUMBER READOUT

Shows the selected operating channel number.
• When a simplex channel is selected, “A” appears.

13 CHANNEL NAME FIELD

The channel name appears, if programmed. (p. 13)

14 KEY ICON (p. 7)

Shows the programmed function of the softkeys on the front panel.

15 TIME ZONE INDICATOR

- Shows the current time when a GPS receiver is connected, or the time is manually programmed.
 - When the GPS current time is invalid, “??” will blink every 2 seconds instead of the current time. After 23.5 hours has passed, “NO TIME” will appear.
 - “??” will blink every 2 seconds instead of the current time, after 4 hours have passed from when the time was manually programmed. The manually programmed time is held for only 23.5 hours, and after that, “NO TIME” will appear.
- “LOCAL” appears when the offset time is set.
- “MNL” appears when the time is manually programmed.
- “UTC” appears when the GGA, GLL or GNS GPS sentence format is included in the GPS signal.
- The date information appears when the RMC GPS sentence format is included in the GPS signal.
- “NO TIME” appears when no GPS receiver is connected, and no time is manually input.

16 POSITION INDICATOR

- Shows the current position when a GPS receiver is connected, or the position is manually programmed.
 - When the GPS position is invalid, “??” may blink every 2 seconds instead of position. The last position is held for only 23.5 hours, and after that, “NO POSITION” will appear.
 - “??” will blink every 2 seconds instead of position, after 4 hours have passed from when the position is manually programmed. The manually programmed position is held for only 23.5 hours, and after that, “NO POSITION” will appear.
- “NO POSITION” appears when no GPS receiver is connected, and no position is manually input.

17 SCAN INDICATOR

- “SCAN 16” appears during a Priority scan; “SCAN” appears during a Normal scan. (p. 18)
- “DUAL 16” appears during Dualwatch; “TRI 16” appears during Tri-watch. (p. 19)

18 LOCAL ICON (p. 11)

- Appears when the Attenuator function is turned ON.
*Only U.S.A. and Australian version transceivers.

2 PANEL DESCRIPTION

■ Speaker Microphone

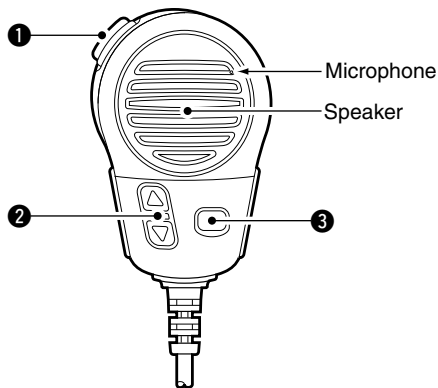

① PTT SWITCH [PTT]

Hold down to transmit, release to receive. (p. 11)

② CHANNEL UP/DOWN KEYS [▲]/[▼]

Push either key to check Favorite channels, change scanning direction or manually resumes a scan. (pp. 11, 18)

③ TRANSMIT POWER KEY [HI/LO]

- Push to toggle the power high or low. (p. 11)
 - Some channels are set to only low power.
- While holding down [HI/LO], turn ON the power to turn the Microphone Lock function ON or OFF. (p. 14)

■ Softkey function

Various functions can be assigned to the softkeys. When a key function is assigned, the key icon is displayed above the softkey, as shown below. Consult your Icom dealer for details concerning which functions are preprogrammed into the keys.

◇ Softkey function selection

- When “◀” or “▶” is displayed beside the key icon, pushing [◀] or [▶] sequentially shows the previous or next key function that is assigned to the softkey.

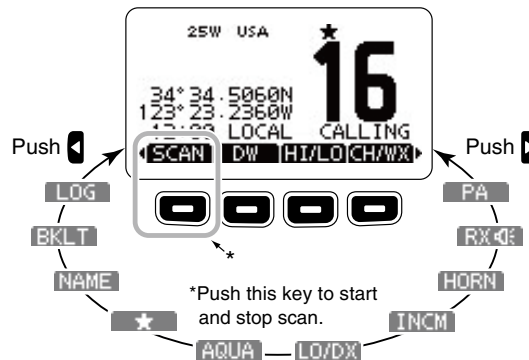

/// The order of the key icons may differ, depending on the preprogramming.

/// For Chinese version transceiver:

- [CHAN] appears instead of [CHWX].
- [LO/DX] does not appear.

■ MMSI code programming

The 9 digit MMSI (Maritime Mobile Service Identity: DSC self ID) code can be programmed at power ON.

This initial code setting can be performed only once. After being set, it can be changed by only your dealer or distributor. If your MMSI code has already been programmed, this programming is not necessary.

- ① Hold down [PWR](Dial) to turn ON the power.
 - Three short beeps sound, and “NO DSC MMSI” is displayed.
- ② Push [ENT] to start the MMSI code programming.
 - Push [CLEAR] twice to cancel the programming, and go to the normal operating screen. In this case, the transceiver cannot make a DSC call. To program the MMSI code, turn OFF the power, then turn it ON again.
- ③ Enter your MMSI code in the following manner:
 - Select a desired number using Dial, or [▲]/[▼]/[◀]/[▶].
 - Push [ENT] or Dial to set it.
 - To move the cursor, select either arrow, “←” or “→,” then push [ENT] or Dial.

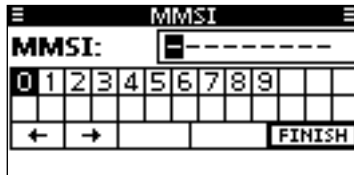

- ④ Repeat step ③ to enter all 9 digits.
- ⑤ After entering the 9 digit code, “FINISH” is automatically selected, and then push [ENT] or Dial to set it.
- ⑥ The “MMSI CONFIRMATION” screen is displayed.

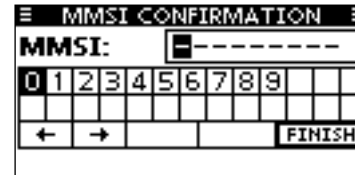

- ⑦ Enter your MMSI code again for confirmation.
 - Enter in the same manner as steps ③ through ⑤.
- ⑧ When your MMSI code programming is successfully completed, the screen as shown below is briefly displayed.
 - After that, the normal operating screen is displayed.



The programmed MMSI code can be checked in the MENU screen. (p. 76)

■ Channel selection

◇ Channel 16

Channel 16 is the distress and safety channel. It is used for establishing initial contact with a station and for emergency communications. Channel 16 is monitored during both Du-alwatch and Tri-watch. While standing by, you must monitor Channel 16.

- Push [16/C] to select Channel 16.
- Push [CH/WX]* to return to the screen displayed before you selected Channel 16, or push [▲](CH) or [▼](CH) to select an operating channel.

*[CHAN] appears only for Chinese version transceiver.



◇ Call channel

Each regular channel group has a separate leisure use Call channel. The Call channel is monitored during Tri-watch. The Call channels can be programmed, and are used to store your most often used channel in each channel group, for quick recall. (p. 13)

- Hold down [16/C] for 1 second to select the Call channel of the selected channel group.
 - “CALL” and the Call channel number appear.
 - Each channel group has an independent call channel after programming. (p. 13)
- Push [CH/WX]* to return to the screen displayed before you selected Call channel, or push [▲](CH) or [▼](CH) to select an operating channel.

*[CHAN] appears only for Chinese version transceiver.



◇ Channel group selection

There are preprogrammed U.S.A. channels, International channels and Canadian channels. These channel groups may be specified for the operating area.

- ① Push [MENU].
- ② Rotate Dial or push [▲]/[▼] to select “Radio Settings,” and then push [ENT].
- ③ Rotate Dial or push [▲]/[▼] to select “CHAN Group,” and then push [ENT].



- ④ Rotate Dial or push [▲]/[▼] to select the desired channel group, and then push [ENT].
 - U.S.A. (USA), International (INT) and Canadian (CAN) channel groups can be selected.



- ⑤ Push [EXIT] to exit the Menu screen.
- ⑥ Push [▲](CH) or [▼](CH) to select a channel.
 - Pushing [▲]/[▼] on the microphone selects only Favorite channels.
 - “DUP” appears when a duplex channel is selected.
 - “A” appears when a simplex channel is selected.

Channel group icon appears

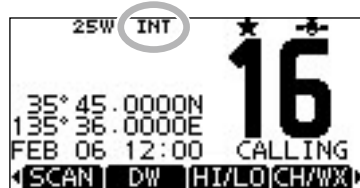

When the International channel group is selected.

4 BASIC OPERATION

◇ Weather channels

(U.S.A. and Australian version transceiver only)

The transceiver has 10 weather channels. These are used for monitoring broadcasts from NOAA (National Oceanographic and Atmospheric Administration.)

The transceiver can automatically detect a weather alert tone on the selected weather channel or while scanning. (p. 17)

- ① Push [CH/WX] once or twice to select a weather channel.
 - “WX” appears when a weather channel is selected.
 - “WX ” appears when the Weather Alert function is in turned ON. (p. 78)
- ② Push [▲](CH) or [▼](CH) to select a channel.
 - Pushing [▲]/[▼] on the microphone selects only Favorite channels.



When weather alert is OFF.



When weather alert is ON.

■ Receiving and transmitting

 **CAUTION:** Transmitting without an antenna will damage the transceiver.

- ① Hold down [PWR](Dial) to turn ON the power.
- ② Set the audio and squelch levels. (p. 15)
 - ➔ First, open the squelch. Then, adjust the audio output level. After that, adjust the squelch level until the noise just disappears.
- ③ Change the channel group. (p. 10)
- ④ Push [▲](CH) or [▼](CH) to select a channel. (pp. 9, 10)
 - Pushing [▲]/[▼] on the microphone selects only Favorite channels.
 - When receiving a signal, “**BUSY**” appears and audio is heard.
 - Further adjustment of the volume level may be necessary.
- ⑤ Push [LO/DX] to turn the receive Attenuator function ON or OFF, if necessary.
 - Only U.S.A. and Australian version transceivers.
 - “LOCAL” appears when the receive Attenuator function is ON.
- ⑥ Push [HI/LO] to select the output power, if necessary.
 - “25W” appears when high power is selected, and “1W” appears when low power is selected.
 - Choose low power for short range communications, choose high power for longer distance communications.
 - Some channels are for only low power.
- ⑦ Hold down [PTT] to transmit, then speak at your normal voice level.
 - “**TX**” appears.
 - Channel 70 cannot be used for transmission other than DSC.
- ⑧ Release [PTT] to receive.

✓ **Information**

The Noise Cancel function reduces random noise components in the transmit and/or receive signal. See page 80 for details.

/// Simplex channels, 3, 21, 23, 61, 64, 81, 82 and 83 CANNOT be lawfully used by the general public in U.S.A. waters.

/// **IMPORTANT:** To maximize the readability of your transmitted signal, pause a few seconds after pushing [PTT], hold the microphone 5 to 10 cm (2 to 4 inches) from your mouth and speak at a normal voice level.

✓ **NOTE for the TOT (Time-out Timer) function**

The TOT function inhibits continuous transmission beyond a preset time period after the transmission starts.

10 seconds before transmission is cutoff, a beep sounds to indicate the transmission will be shut down and "TOT" appears in the channel name field. Transmission is not possible for 10 seconds after this shut down.

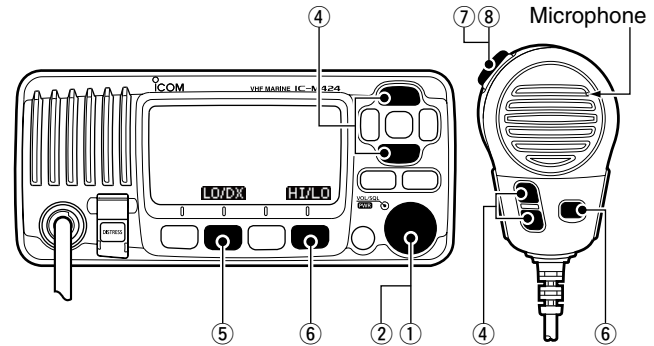

4 BASIC OPERATION

■ Call channel programming

You can program the Call channel with your most often-used channel in each channel group for quick recall.

- ① Select the desired channel group (INT, USA or CAN) to be programmed. (p. 10)
- ② Hold down [16/C] for 1 second to select the Call channel of the selected channel group.
 - "CALL" and the Call channel number appear.
- ③ Hold down [16/C] again for 3 seconds (until a long beep changes to 2 short beeps) to enter the Call channel programming mode.
- ④ Rotate Dial or push [▲](CH)/[▼](CH) to select a channel.

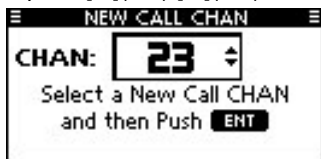

- ⑤ Push [ENT] to program the displayed channel as the Call channel.
 - Push [CLEAR] to cancel.



■ Channel name programming

Each channel can be assigned a unique alphanumeric ID of up to 10 characters.

Capital letters, 0 to 9, some symbols (! " # \$ % & ' () * + , - . / [\] ^ _ ; < = > ?) and a space can be input.

- ① Push [▲](CH) or [▼](CH) to select a channel.
 - First, cancel the Dualwatch, Tri-watch or Scan function, if activated.
- ② Push [NAME] to open the channel name programming screen.
 - A black box is displayed on the first character.
- ③ Enter the desired channel name in the following manner:
 - Select a desired character using Dial, or [▲]/[▼]/[◀]/[▶].
 - Push [ENT] to set it.
 - To move the cursor, select either arrow, "←" or "→," then push [ENT].
 - Select "SPACE," then push [ENT] to input a space.
 - Select "DELETE," then push [ENT] to delete a character.
 - Push [CLEAR] to cancel and return to the previous screen.



- ④ Repeat step ③ to input all characters.



- ⑤ Push [◀], [▶], [▲] or [▼] to select "FINISH," then push [ENT] to set the name and return to the previous screen.



Microphone Lock function

The Microphone Lock function electrically locks [▲], [▼] and the [HI/LO] keys on the supplied microphone. This prevents accidental channel changes and function access.

- ▶ While holding down [HI/LO] on the microphone, hold down [PWR](Dial) to turn ON the transceiver and turn the Microphone Lock function ON or OFF.

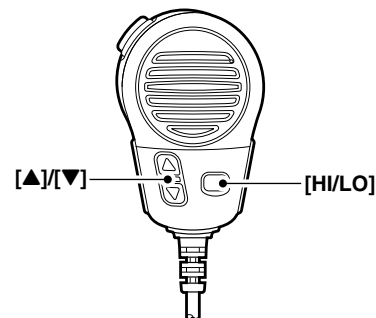

4 BASIC OPERATION

■ Adjusting the volume level

The volume level can be adjusted with [VOL/SQL](Dial).

- ① Rotate [VOL/SQL](Dial), or push [VOL/SQL](Dial) one or more times to display the volume adjustment screen.
- ② Rotate [VOL/SQL](Dial) to adjust the volume level.
 - The transceiver has 20 volume levels and OFF.
 - If no key operation is performed for about 5 seconds, the transceiver sets the selected volume level, and returns to the normal mode.
- ③ Push [ENT] to set the level, and exit the volume adjustment mode.
 - Push [CLEAR] to cancel.

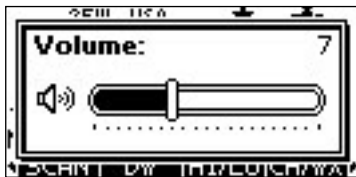

/// The desired function can be assigned to Dial. See page 79 for details.

■ Adjusting the squelch level

The squelch level can be adjusted with [VOL/SQL](Dial).

In order to receive signals properly, as well as for the scan to function effectively, the squelch must be adjusted to the proper level.

- ① Push [VOL/SQL](Dial) one or more times to display the squelch adjustment screen.
- ② Rotate [VOL/SQL](Dial) to adjust the squelch level.
 - The transceiver has 11 squelch levels: OPEN is completely open; 10 is tight squelch; 1 is loose squelch.
 - If no key operation is performed for about 5 seconds, the transceiver sets the selected squelch level, and returns to the normal mode.
- ③ Push [ENT] to set the level, and exit the squelch adjustment mode.
 - Push [CLEAR] to cancel.

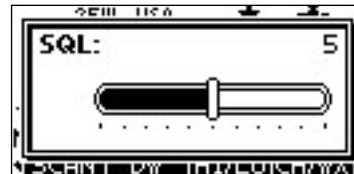

/// The desired function can be assigned to Dial. See page 79 for details.

■ Adjusting the display backlight level

The function display and keys can be backlit for better visibility under low light conditions.

The backlight is adjustable in 7 levels and OFF.

Depending on the preprogramming, the adjustment method differs, as described below.

- ➔ Push [BKLT] to show the backlight adjustment screen. Rotate Dial to adjust the brightness of the LCD and key backlight, and then, push [ENT].
 - If no key operation is performed for about 5 seconds, the transceiver sets the selected backlight level, and returns to the normal mode.

When the Backlight function is assigned to the [VOL/SQL](Dial):

- ① Push [VOL/SQL](Dial) one or more times to display the backlight adjustment screen.
- ② Rotate [VOL/SQL](Dial) to adjust the brightness of the LCD and key backlight, and then, push [ENT].



/// The desired function can be assigned to Dial. See page 79 for details.

■ AquaQuake water draining function

The AquaQuake water draining function clears water away from the speaker grill. Without this function, water may muffle the sound coming from the speaker. A buzzing sound is heard when this function is activated.

- ➔ While holding down [AQUA], the AquaQuake function is activated to clear water away from the speaker grill.
 - While holding down [AQUA], a low buzzing sounds to drain water, regardless of the volume level setting.
 - The transceiver keys, except [DISTRESS], are disabled while the AquaQuake function is activated.



When the AquaQuake function is activated.

■ Scan types

Scanning is an efficient way to locate signals quickly over a wide frequency range. The transceiver has a Priority scan and a Normal scan.

When the Weather Alert function is turned ON, the weather channel is also checked while scanning. (p. 78)

PRIORITY SCAN

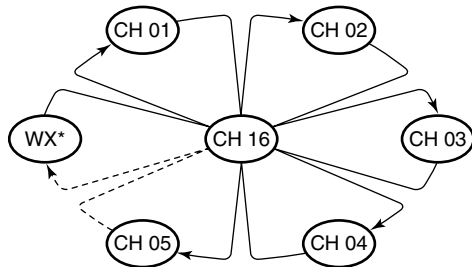

*When the weather alert function is activated.

The Priority scan sequentially searches through all Favorite channels while monitoring Channel 16. When a signal is detected on Channel 16, the scan pauses until the signal disappears. When a signal is detected on a channel other than Channel 16, the scan becomes a Dualwatch until the signal disappears.

Set the Favorite channels (scanned channel) before scanning. Clear the Favorite channels which inconveniently stop scanning, such as those for digital communication use. (Refer to the next page for details.)

/// Choose Priority or Normal scan in the Menu screen. (p. 77)

NORMAL SCAN

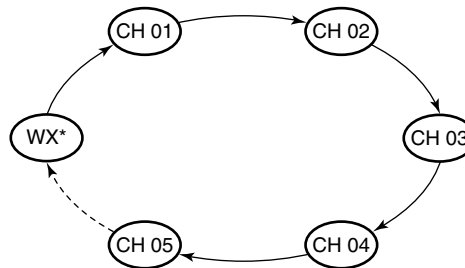

*When the weather alert function is activated.

The Normal scan, like the Priority scan, sequentially searches through all Favorite channels. However, unlike the Priority scan, Channel 16 is not checked unless it is set as a Favorite channel.

■ Setting Favorite channels

For more efficient scanning, add desired channels as Favorite channels, or clear the Favorite on unwanted channels. Channels that are not tagged will be skipped while scanning. Favorite channels can be independently assigned to each channel group (INT, USA, or CAN).

- ① Select the desired channel group. (p. 10)
- ② Select the desired channel to be set as a Favorite channel.
- ③ Push [★] to set the displayed channel as a Favorite channel.
 - “★” appears on the display.
- ④ To cancel the Favorite channel setting, repeat step ③.
 - “★” disappears.

✓ Clearing (or setting) all Favorite channels

Hold down [★] for 3 seconds (until a long beep changes to 2 short beeps) to clear all Favorite channel settings in the selected channel group.

- Repeat above procedure to set all channels as Favorite channels.

■ Starting a scan

First, set the scan type (Priority or Normal scan) and scan resume timer in the Menu screen. (p. 77)

- ① Select the desired channel group. (p. 10)
- ② Set the Favorite channels, as described to the left.
- ③ Make sure the squelch is closed to start a scan.
- ④ Push [SCAN] to start a Priority or Normal scan.
 - “SCAN 16” appears during a Priority scan; “SCAN” appears during a Normal scan.
 - When a signal is detected, the scan pauses until the signal disappears, or resumes after pausing 5 seconds, depending on the setting. (Channel 16 is still monitored during a Priority scan.)
 - Push [▲]/[▼] on either transceiver or microphone, to check the scanning Favorite channels, change the scanning direction or manually resume the scan.
 - A beep tone sounds and “16” blinks when a signal is received on Channel 16 during a Priority scan.
- ⑤ To stop the scan, push [CLEAR] or repeat step ④.

[Example]: Starting a Normal scan.



Push
[SCAN]

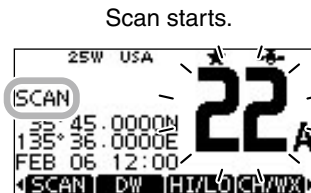

Scan starts.

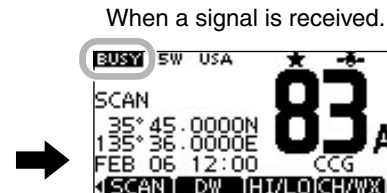

When a signal is received.

■ Description

Dualwatch monitors Channel 16 while you are receiving on another channel; Tri-watch monitors Channel 16 and the Call channel while receiving another channel. Dualwatch and Tri-watch are convenient for monitoring Channel 16 when you are operating on another channel.

DUALWATCH/TRI-WATCH SIMULATION

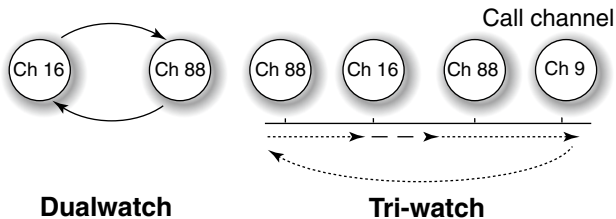

- If a signal is received on Channel 16, Dualwatch and Tri-watch pause on Channel 16 until the signal disappears.
- If a signal is received on the Call channel during Tri-watch, Tri-watch becomes Dualwatch until the signal disappears.
- To transmit on the selected channel during a Dualwatch or Tri-watch scan, hold down [PTT].

■ Operation

- ① Select Dualwatch or Tri-watch in the Menu screen. (p. 77)
- ② Push [▲](CH) or [▼](CH) to select the desired operating channel.
- ③ Push [DW] to start a Dualwatch or Tri-watch scan.
 - “DUAL 16” appears during Dualwatch; “TRI 16” appears during Tri-watch.
 - A beep tone sounds when a signal is received on Channel 16.
- ④ To cancel Dualwatch or Tri-watch, push [DW] again.

[Example]: Operating Tri-watch on INT Channel 25.

Tri-watch starts.

```

25W USA DUF ★
TRI 16
35° 45.0000N 25
135° 36.0000E
FEB 06 12:00 TELEPHONE
└─SCAN┘ └─DW┘ └─HI/LO┘ └─CH/WXL┘
  
```

Signal is received on Call channel.

```

BUSY 25W USA DUF ★
CALL
TRI 16
35° 45.0000N 16
135° 36.0000E
FEB 06 12:00 CALLING
└─SCAN┘ └─DW┘ └─HI/LO┘ └─CH/WXL┘
  
```

Tri-watch resumes after the signal disappears.

```

25W USA DUF ★
TRI 16
35° 45.0000N 25
135° 36.0000E
FEB 06 12:00 TELEPHONE
└─SCAN┘ └─DW┘ └─HI/LO┘ └─CH/WXL┘
  
```

Signal received on Channel 16 takes priority.

```

BUSY 25W USA DUF ★
TRI 16
35° 45.0000N 25
135° 36.0000E
FEB 06 12:00 TELEPHONE
└─SCAN┘ └─DW┘ └─HI/LO┘ └─CH/WXL┘
  
```

■ DSC address ID

◇ Programming Individual ID

A total of 100 DSC address IDs can be programmed and assigned a name of up to 10 characters.

- ① Enter “INDIVIDUAL ID” in the DSC SETTINGS menu.

<MENU> ⇄ <DSC Settings> ⇄ <Individual ID>
 (Push [MENU]) (Rotate Dial, then push [ENT].)

- ② Push [ADD].

• The “INDIVIDUAL ID” program screen is displayed.

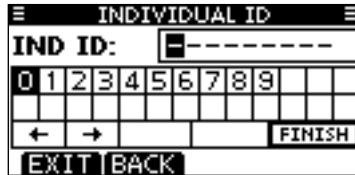

- ③ Enter a desired individual ID in the following way:

- Select a desired number using Dial, or [▲]/[▼]/[◀]/[▶].
- Push [ENT] or Dial to set it.
- To move the cursor, select either arrow, “←” or “→,” then push [ENT] or Dial.

- ▨ The first digit is specified as ‘0’ for a Group ID.
- ▨ The first two digits are ‘0’ for any Coast station ID.

- ④ Repeat step ③ to enter all 9 digits.

- ⑤ After entering the 9 digit code, push [ENT] or Dial to set it.
- The ID name programming screen is displayed.



- ⑥ Enter a desired 10 digit ID name in the following way:

- Select a desired character using Dial, or [▲]/[▼]/[◀]/[▶].
- Push [ENT] or Dial to set it.
- To move the cursor, select either arrow, “←” or “→,” then push [ENT] or Dial.
- Push [123] then [!\$?] then [ABC] to select a character group.

- ⑦ After entering the ID name, select “FINISH” using Dial, or [▲]/[▼]/[◀]/[▶], then push [ENT] or Dial to program it.

- The “INDIVIDUAL ID” list screen is displayed.



- ⑧ Push [MENU] to exit the MENU screen.

7 DSC OPERATION

◇ Programming Group ID

- ① Enter "GROUP ID" in the DSC SETTINGS menu.

◀MENU	⇄	◀DSC Settings	⇄	◀Group ID
(Push [MENU])		(Rotate Dial, then push [ENT].)		

- ② Push [ADD].

- The "GROUP ID" program screen is displayed.



- ③ Enter a desired group ID in the following way:
- Select a desired number using Dial, or [▲]/[▼]/[◀]/[▶].
 - Push [ENT] or Dial to set it.
 - To move the cursor, select either arrow, "←" or "→," then push [ENT] or Dial.
- /// The first digit is fixed as '0' for a Group ID.
/// The first two digits are '0' for any Coast station ID.

- ④ Repeat step ③ to input the specific 9 digits group code.

- ⑤ After entering the 9 digit code, push [ENT] or Dial to set it.
- The Group ID name programming screen is displayed.



- ⑥ Enter a desired 10 digit ID name in the following way:
- Select a desired character using Dial, or [▲]/[▼]/[◀]/[▶].
 - Push [ENT] or Dial to set it.
 - To move the cursor, select either arrow, "←" or "→," then push [ENT] or Dial.
 - Push [123], [!\$?] or [ABC] to select a character group.
- ⑦ After entering the ID name, select "FINISH" using Dial, or [▲]/[▼]/[◀]/[▶], then push [ENT] or Dial to program it.
- The "GROUP ID" list screen is displayed.



- ⑧ Push [MENU] to exit the MENU screen.

◆ **Deleting Individual/Group ID**

- ① Enter “INDIVIDUAL ID” or “GROUP ID” in the DSC SETTINGS menu.

◀MENU▶ ⇄ ▶DSC Settings▶ ⇄ ▶Individual ID▶/▶Group ID▶
 (Push [MENU]) (Rotate Dial, then push [ENT].)

- When no address ID is programmed, “No ID” is displayed. In this case, push [MENU] to exit the MENU screen.

- ② Rotate Dial or push [▲]/[▼] to select a desired ID name, then push [DEL].

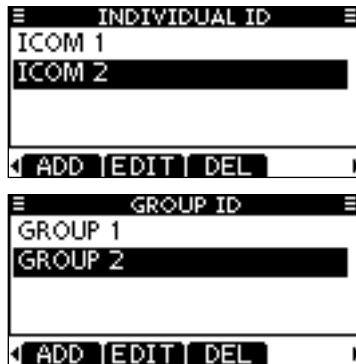

- ③ Push [OK] to delete the ID, and return to the “INDIVIDUAL ID” or “GROUP ID” list screen.
 - Push [CANCEL] to cancel it.



- ④ Push [MENU] to exit the MENU screen.

■ Position and time programming

A Distress call should include the ship's position and time. If no GPS is connected, your position and UTC (Universal Time Coordinated) time should be manually input. They are automatically included when a GPS receiver compatible with the NMEA0183 ver. 2.0 or 3.01 format is connected.

- ▨ Manual programming is disabled when a GPS receiver is connected.
- ▨ Manually programmed position and time will be held for only 23.5 hours.

① Enter "POSITION INPUT" in the DSC SETTINGS menu.

◀MENU> ⇄ ▶DSC Settings> ⇄ ▶Position Input>
 (Push [MENU]) (Rotate Dial, then push [ENT].)

② Edit your latitude and longitude position using Dial, or [▲]/[▼]/[◀]/[▶].

- Select a desired number using Dial, or [▲]/[▼]/[◀]/[▶].
- Push [ENT] or Dial to set it.
- To move the cursor, select either arrow, "←" or "→," then push [ENT] or Dial.
- Select N (North latitude) or S (South latitude) when the cursor is on the 'N' or 'S' position.
- Select W (West longitude) or E (East longitude) when the cursor is on the 'W' or 'E' position.

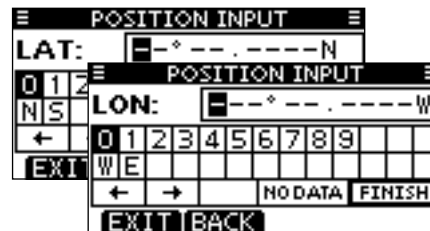

- ③ After entering the position, push [ENT] to program it.
- ④ The UTC time programming screen is displayed, enter the UTC time in the following way:
 - Select a desired number using Dial, or [▲]/[▼]/[◀]/[▶].
 - Push [ENT] or Dial to set it.
 - To move the cursor, select either arrow, "←" or "→," then push [ENT] or Dial.

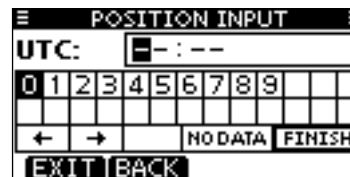

- ⑤ Push [ENT] or Dial to program your position and time.
 - Return to the "DSC SETTINGS" screen.

■ Distress call

A Distress call should be transmitted if, in the opinion of the Master, the ship or a person is in distress and requires immediate assistance.

NEVER MAKE A DISTRESS CALL IF YOUR SHIP OR A PERSON IS NOT IN AN EMERGENCY. A DISTRESS CALL SHOULD BE MADE ONLY WHEN IMMEDIATE HELP IS NEEDED.

◇ Simple call

- ① Confirm no Distress call is being received.
- ② While lifting up the key cover, hold down [DISTRESS] for 3 seconds to transmit the Distress call.
 - While holding down [DISTRESS], count down beeps sound and both the key and display backlighting blink.
 - DSC channel (Channel 70) is automatically selected and the Distress call is transmitted.

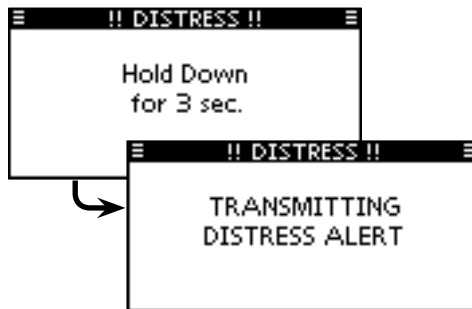

- ③ After transmitting the call, the transceiver waits for an acknowledgment call.
 - The Distress call is automatically transmitted every 3.5 to 4.5 minutes, until an acknowledgement is received ('Call repeat' mode), or DSC Cancel call is made. (p. 27)
 - Push [RESEND] to manually transmit the Distress repeat call.
 - Push [◀]/[▶] then push [INFO] to display the transmitted Distress call information.
 - Push [◀]/[▶] then push [PAUSE] to pause the 'Call repeat' mode, push [RESUME] to resume it.



- ④ After receiving the acknowledgment, push [ALARM OFF] then reply using the microphone.
 - ➔ A distress alert default contains:
 - Nature of distress : Undesignated distress
 - Position information : The latest GPS or manual input position is held for 23.5 hours, or until the power is turned OFF.

7 DSC OPERATION

◇ Regular call

The nature of the Distress call should be included in the Distress call.

- ① Enter "DISTRESS CALL" in the DSC CALLS menu.

<MENU> ⇨ **<DSC Calls>** ⇨ **<Distress Call>**
(Push [MENU]) (Rotate Dial, then push [ENT].)

- ② Select the nature of the distress using Dial or [▲]/[▼], then push Dial or [ENT].

- 'Undesignated,' 'Fire,Explosion,' 'Flooding,' 'Collision,' 'Grounding,' 'Capsizing,' 'Sinking,' 'Adrift,' 'Abandoning ship,' 'Piracy' or 'Man Overboard' is selectable.
- The nature of the distress is stored for 10 minutes after a selection is made.

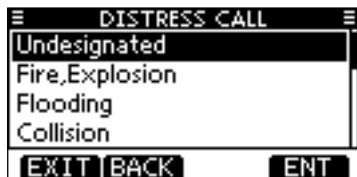

- ③ The Distress call confirmation screen is displayed.
- Rotate Dial or push [▲]/[▼] to see the hidden lines.

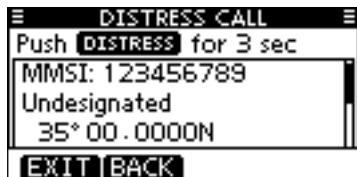

- ④ Hold down [DISTRESS] for 3 seconds to transmit the Distress call.
 - While holding down [DISTRESS], count down beeps sound and both the key and display backlighting blink.
 - The selected nature of the distress is stored for 10 minutes.

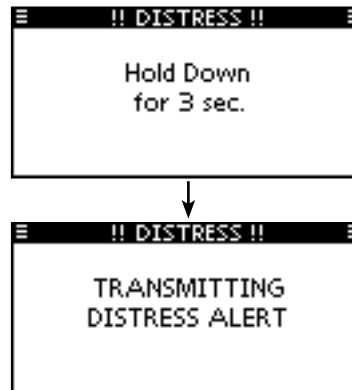

- ⑤ After transmitting the call, the transceiver waits for an acknowledgment call.
- The Distress call is automatically transmitted every 3.5 to 4.5 minutes, until an acknowledgement is received ('Call repeat' mode), or DSC cancel call is made. (p. 27)
 - Push [RESEND] to manually transmit the Distress repeat call.
 - Push [◀]/[▶] then push [INFO] to display the transmitted Distress call information.
 - Push [◀]/[▶] then push [PAUSE] to pause the 'Call repeat' mode, push [RESUME] to resume it.



- ⑥ After receiving an acknowledgment call, push [ALARM OFF] then reply using the microphone.



- ➔ A distress alert contains:
- Nature of distress : Selected in step ②.
 - Position information : The latest GPS or manual input position is held for 23.5 hours, or until the power is turned OFF.

When no GPS receiver is connected, and both position and time have been manually programmed, the screen as shown below appears. Edit your latitude and longitude position and UTC time as follows:

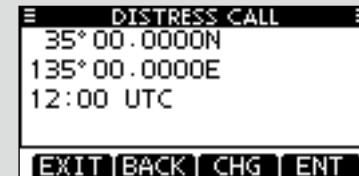

- ➔ Push [CHG], then edit your latitude and longitude position and UTC time.
- Select a desired number using Dial, or [▲]/[▼]/[◀]/[▶].
 - Push [ENT] or Dial to set it.
 - To move the cursor, select either arrow, “←” or “→,” then push [ENT] or Dial.
 - Select N (North latitude) or S (South latitude) when the cursor is on the 'N' or 'S' position.
 - Select W (West longitude) or E (East longitude) when the cursor is on the 'W' or 'E' position.



7 DSC OPERATION

◇ Distress cancel call

- ① While waiting for an acknowledgment call, push [CANCEL].

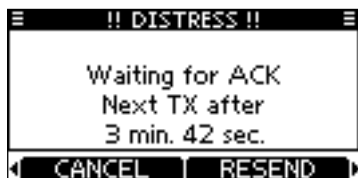

- ② Push [CONTINUE].
- Push [BACK] to return to waiting for an acknowledgement call.



- ③ Push [FINISH].
- Push [EXIT] to return to waiting for an acknowledgement call.



- ④ The Distress cancel call is transmitted.

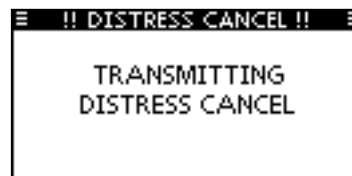

- ⑤ Channel 16 is automatically selected.
- Report your situation using the microphone.
 - After the report, push [EXIT] to return to the normal operating mode.



■ Transmitting DSC calls

/// To ensure correct operation of the DSC function, make sure you correctly set the CH70 SQL LEVEL. (p. 69)

◇ Transmitting an individual call

The Individual call function allows you to transmit a DSC signal to only a specific station.

- 1 Enter "INDIVIDUAL CALL" in the DSC CALLS menu.

◀MENU> ⇄ <DSC Calls> ⇄ <Individual Call>
 (Push [MENU]) (Rotate Dial, then push [ENT].)

- 2 Select the desired preprogrammed individual address, or "Manual Input," using Dial or [▲]/[▼], then push Dial or [ENT].
 - The ID code for the Individual call can be set first. (p. 20)
 - When "Manual Input" is selected, set a desired 9 digit MMSI ID code for the individual you wish to call.

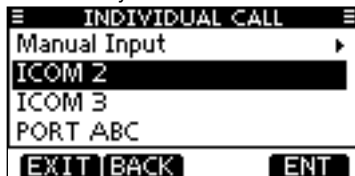

/// About Manual Inputting:

Enter a desired individual ID in the following way:

- Select a desired number using Dial, or [▲]/[▼]/[◀]/[▶].
- Push [ENT] or Dial to set it.
- To move the cursor, select either arrow, "←" or "→," then push [ENT] or Dial.
- The first digit is specified as '0' for a Group ID. If a Group ID is entered, an error beep sounds after pushing [FINISH].
- The first two digits are '0' for any coast station ID.

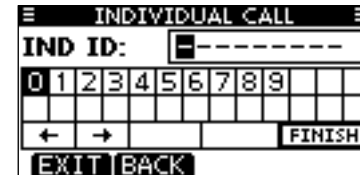

- 3 Select Routine, Safety or Urgency as the desired call type using Dial or [▲]/[▼], then push [ENT].



/// **NOTE:** When a coast station is selected in step ②, the voice channel is automatically specified by the coast station. Therefore, skip step ④ and go directly to step ⑤.

ⓘ Continued on the next page.

7 DSC OPERATION

◇ Transmitting an Individual call (continued)

④ Select a desired intership channel using Dial or [▲](CH)/[▼](CH), then push [ENT].

- Intership channels are already preset into the transceiver in the recommended order.



⑤ A confirmation screen appears.

- Confirm the call contents.

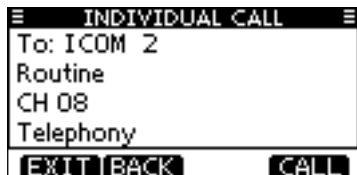

⑥ Push [CALL] to transmit the Individual call.

- If Channel 70 is busy, the transceiver stands by until the channel becomes clear.

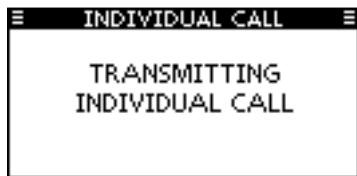

⑦ Standby on Channel 70 until an acknowledgement is received.

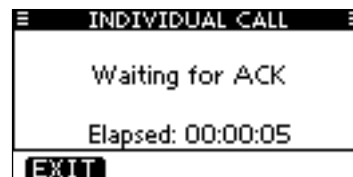

⑧ When the acknowledgement 'Able to comply' is received, beeps sound and the screen below is displayed.



Push [ALARM OFF] to stop the beeps and then select the intership channel specified in step ④.

- A different intership channel will be selected if the station you called cannot use the channel.
- Reply using the microphone. And go to step ⑨.

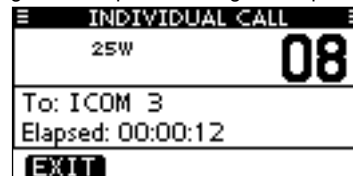

Or, when the acknowledgement 'Unable to comply' is received, beeps sound and the screen below is displayed.



Push [ALARM OFF] to stop the beeps. Then push [EXIT] to return to the operating channel (before you entered the MENU screen).

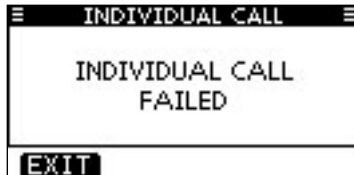

- ⑨ After communicating, push [EXIT] to return to the normal operating mode.

✓ Convenient!

When the optional MA-500TR CLASS B AIS TRANSPONDER is connected to your transceiver, you can transmit individual DSC calls to selected AIS targets on the transponder without needing to enter the target's MMSI code. See pages 70 and 84 for more details.

◇ Transmitting an Individual Acknowledgement

When receiving an Individual call, you can transmit an acknowledgement ('Able to Comply,' 'Propose New Channel' or 'Unable to Comply') by using the on-screen prompts (Quick ACK.) Also, you can send an acknowledgement through the MENU system (Manual ACK.)

Quick ACK:

- ① When an Individual call is received, beeps sound and the screen below is displayed. Push [ALARM OFF] to stop the beeps.



- ② Push [ACK].

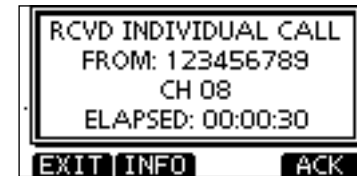

☞ Continued on the next page.

7 DSC OPERATION

◇ Transmitting an Individual Acknowledgement (continued)

③ Select one of three options, then push [ENT].



- **Able to Comply** : Make an acknowledgment call without any changes.
- **Unable to Comply** : You cannot make a communication. The Acknowledgement call ('Unable to Comply') can be automatically transmitted, if set. See page 66 for details.
- **Propose New Channel** : You can make an acknowledgement call, but you specify the intership channel. Select a desired intership channel, using Dial, or [▲](CH)/[▼](CH), then push [ENT].

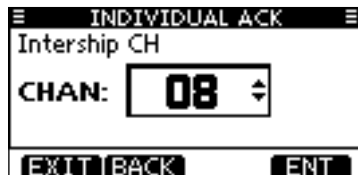

④ The Individual ACK confirmation screen is displayed. Push [CALL] to transmit an acknowledgement call.

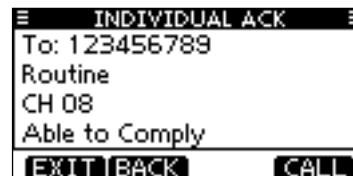

⑤ The screens shown below are displayed.

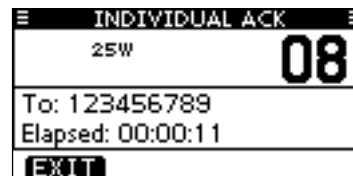
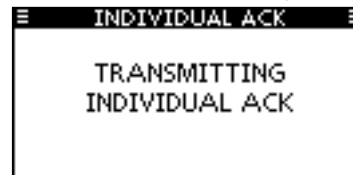

- ⑥ Reply to the call using the microphone.
- ⑦ Push [EXIT] to return to the normal operating mode.

Manual ACK:

- ① Enter "INDIVIDUAL ACK" in the DSC CALLS menu.

◀[MENU] ⇄ ▶ ◀DSC Calls⇄ ▶ ◀Individual ACK
 (Push [MENU]) (Rotate Dial, then push [ENT].)

- When no Individual call has been received, "Individual ACK" item will not be displayed.



- ② Select a desired individual address or ID code to reply to, using Dial or [▲]/[▼], then push [ENT].

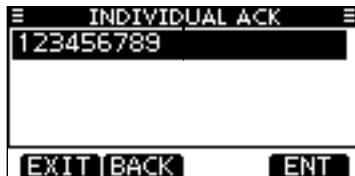

- ③ Perform steps ③ to ⑦, as described in "Quick ACK:," beginning on the previous page.

◇ **Transmitting a Group call**

The Group call function allows you to transmit a DSC signal to only a specific group.

- ① Enter "GROUP CALL" in the DSC CALLS menu.

◀[MENU] ⇄ ▶ ◀DSC Calls⇄ ▶ ◀Group Call
 (Push [MENU]) (Rotate Dial, then push [ENT].)

- ② Select the desired preprogrammed group address or "Manual Input," using Dial or [▲]/[▼], then push Dial or [ENT].
 - The ID code for the Group call can be set first. (p. 21)
 - When "Manual Input" is selected, set the 8 digit ID code for the group you wish to call.



- ③ Select a desired intership channel using Dial or [▲](CH)/[▼](CH), then push [ENT].
 - Intership channels are already preset into the transceiver in the recommended order.



☞ Continued on the next page.

7 DSC OPERATION

◇ Transmitting a Group call (continued)

About Manual Inputting:

Enter a desired group ID in the following way:

- Select a desired number using Dial, or [▲]/[▼]/[◀]/[▶].
- Push [ENT] or Dial to set it.
- To move the cursor, select either arrow, “←” or “→,” then push [ENT] or Dial.
- The first digit is specified as '0' for a Group ID.
- The first two digits are '0' for any Coast station ID.



④ A confirmation screen appears.

- Confirm the call contents.



⑤ Push [CALL] to transmit the Group call.

- If Channel 70 is busy, the transceiver stands by until the channel becomes clear.



⑥ After the Group call has been transmitted, the following screen is displayed.



⑦ Announce the information using the microphone.

⑧ After the announcement, push [EXIT] to return to the normal operating mode.

◇ Transmitting an All Ships call

All ships, that have DSC transceiver, use Channel 70 as their 'listening channel.' When you want to announce a message to these ships within range, use the 'All Ships Call' function.

- 1 Enter "ALL SHIPS CALL" in the DSC CALLS menu.

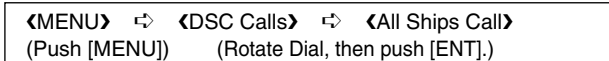

- 2 Select a desired category, using Dial or [▲]/[▼], then push Dial or [ENT].

- The selectable category may differ, depending on the programmed setting. Ask your dealer for the selectable categories.

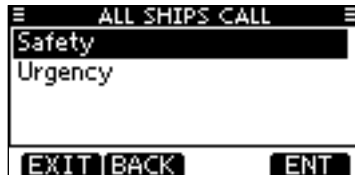

- 3 Select a desired traffic channel, using Dial or [▲]/[▼], then push Dial or [ENT].

- The selected channel is displayed.

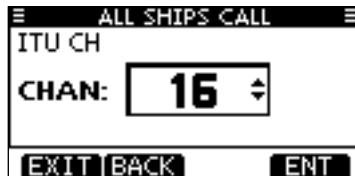

- 4 A confirmation screen appears.

- Confirm the call contents.

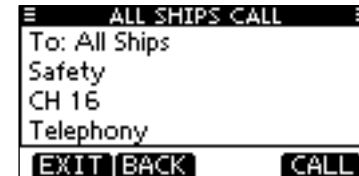

- 5 Push [CALL] to transmit the All Ships call.

- If Channel 70 is busy, the transceiver stands by until the channel becomes clear.



- 6 After the All Ships call has been transmitted, the following screen is displayed.

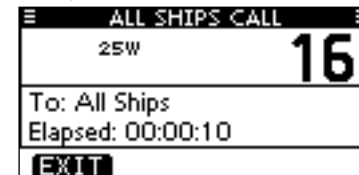

- 7 Announce the message using the microphone.

- 8 After the announcement, push [EXIT] to return to the normal operating mode.

7 DSC OPERATION

◇ Transmitting a Position Request Call

(U.S.A. and Australian version transceiver only)

Transmit a Position Request Call when you want to know a specific ship's current position, etc.

- ① Enter "POSITION REQUEST" in the DSC CALLS menu.

◀MENU▶ ⇄ ▶DSC Calls▶ ⇄ ▶Position Request▶
(Push [MENU]) (Rotate Dial, then push [ENT].)

- ② Select the desired preprogrammed individual address, or "Manual Input," using Dial or [▲]/[▼], then push Dial or [ENT].

- The ID code for the Position Request Call can be set first. (p. 20)
- When "Manual Input" is selected, set a desired 9 digit MMSI ID code for the individual you wish to call.

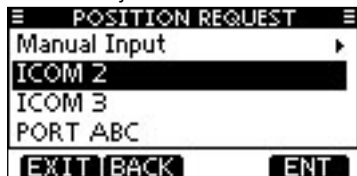

About Manual Inputting:

Enter a desired individual ID in the following way:

- Select a desired number using Dial, or [▲]/[▼]/[◀]/[▶].
- Push [ENT] or Dial to set it.
- To move the cursor, select either arrow, "←" or "→," then push [ENT] or Dial.
- The first digit is specified as '0' for a Group ID. If a Group ID is entered, an error beep sounds after pushing [FINISH].
- The first two digits are '0' for any coast station ID.



- ③ A confirmation screen appears.
 - Confirm the call contents.



- ④ Push [CALL] to transmit the Position Request Call.
- If Channel 70 is busy, the transceiver stands by until the channel becomes clear.



- ⑤ After the Position Request Call has been transmitted, the following screen is displayed.

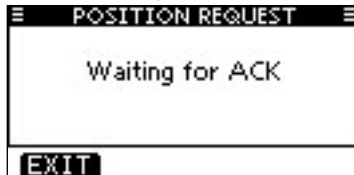

- ⑥ When the acknowledgement call is received, beeps sound and the following screen is displayed.



- ⑦ Push [ALARM OFF] to stop the beeps, and then the screen as shown below is displayed.



- ⑧ Push [EXIT] to return to the normal operating mode.

7 DSC OPERATION

◇ Transmitting a Position Report Call

(U.S.A. and Australian version transceiver only)

Transmit a Position Report Call when you want to announce your own position to a specific ship and receive an answer back.

- ① Enter "POSITION REPORT" in the DSC CALLS menu.

◀MENU▶ ⇄ ▶DSC Calls▶ ⇄ ▶Position Report▶
(Push [MENU]) (Rotate Dial, then push [ENT].)

- ② Select the desired preprogrammed individual address, or "Manual Input," using Dial or [▲]/[▼], then push Dial or [ENT].

- The ID code for the Individual call can be set first. (p. 20)
- When "Manual Input" is selected, set a desired 9 digit MMSI ID code for the individual you wish to call.

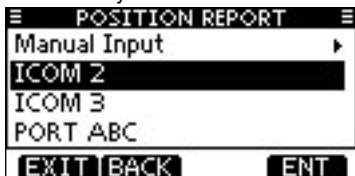

About Manual Inputting:

Enter a desired individual ID in the following way:

- Select a desired number using Dial, or [▲]/[▼]/[◀]/[▶].
- Push [ENT] or Dial to set it.
- To move the cursor, select either arrow, "←" or "→," then push [ENT] or Dial.
- The first digit is specified as '0' for a Group ID. If a Group ID is entered, an error beep sounds after pushing [FINISH].
- The first two digits are '0' for any coast station ID.



- ③ A confirmation screen appears.
- Confirm the call contents.

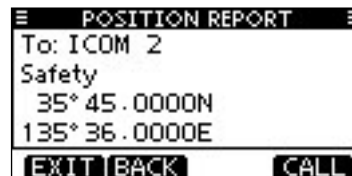

- ④ Push [CALL] to transmit the Position Report Call.
- If Channel 70 is busy, the transceiver stands by until the channel becomes clear.



- ⑤ After the Position Report Call has been transmitted, the transceiver automatically returns to the normal operating mode.

When no GPS receiver is connected, and both position and time have been manually programmed, the screen shown below appears. Edit your latitude and longitude position and UTC time as follows:



- ➔ Push [CHG], then edit your latitude and longitude position and UTC time.
- Select a desired number using Dial, or [▲]/[▼]/[◀]/[▶].
 - Push [ENT] or Dial to set it.
 - To move the cursor, select either arrow, “←” or “→,” then push [ENT] or Dial.
 - Select N (North latitude) or S (South latitude) when the cursor is on the ‘N’ or ‘S’ position.
 - Select W (West longitude) or E (East longitude) when the cursor is on the ‘W’ or ‘E’ position.

7 DSC OPERATION

◇ Transmitting a Polling Request Call

(U.S.A. and Australian version transceiver only)

Transmit a Polling Request Call when you want to know a specific vessel is in the communication area, or not.

- ① Enter “POLLING REQUEST” in the DSC CALLS menu.

◀MENU▶ ⇄ ▶DSC Calls▶ ⇄ ▶Polling Request▶
(Push [MENU]) (Rotate Dial, then push [ENT].)

- ② Select the desired preprogrammed individual address, or “Manual Input,” using Dial or [▲]/[▼], then push Dial or [ENT].

- The ID code for the Individual call can be set first. (p. 20)
- When “Manual Input” is selected, set a desired 9 digit MMSI ID code for the individual you wish to call.

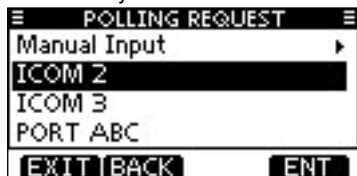

▨ About Manual Inputting:

Enter a desired individual ID in the following way:

- Select a desired number using Dial, or [▲]/[▼]/[◀]/[▶].
- Push [ENT] or Dial to set it.
- To move the cursor, select either arrow, “←” or “→,” then push [ENT] or Dial.
- The first digit is specified as ‘0’ for a Group ID. If a Group ID is entered, an error beep sounds after pushing [FINISH].
- The first two digits are ‘0’ for any coast station ID.



- ③ A confirmation screen appears.

- Confirm the call contents.

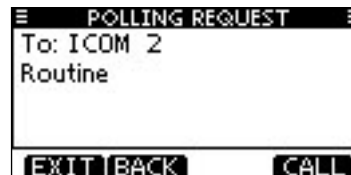

- ④ Push [CALL] to transmit the Polling Request Call.
- If Channel 70 is busy, the transceiver stands by until the channel becomes clear.

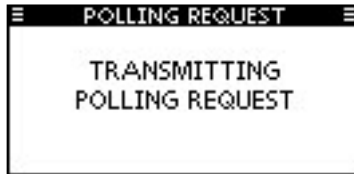

- ⑤ After the Polling Request Call has been transmitted, the following screen is displayed.

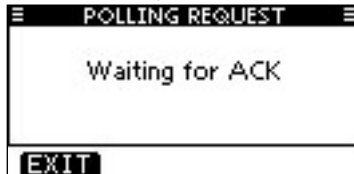

- ⑥ When the acknowledgement call is received, beeps sound and the following screen is displayed.



- ⑦ Push [ALARM OFF] to stop the beeps, and then the screen as shown below is displayed.

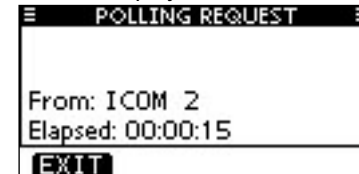

- ⑧ Push [EXIT] to return to the normal operating mode.

7 DSC OPERATION

◇ Transmitting a Test call

Testing on the exclusive DSC distress and safety calling channels should be avoided as much as possible. When testing on a distress/safety channel is unavoidable, you should indicate that these are test transmissions.

Normally the test call would require no further communications between the two stations involved.

- ① Enter “TEST CALL” in the DSC CALLS menu.

◀MENU▶ ⇄ ▶DSC Calls▶ ⇄ ▶Test Call▶
(Push [MENU]) (Rotate Dial, then push [ENT].)

- ② Select a desired preprogrammed individual address, or “Manual Input,” then push Dial or [ENT].
 - The ID code for the Individual call can be set first. (p. 20)
 - When “Manual Input” is selected, set the 9 digit MMSI ID code for the individual you wish to call.

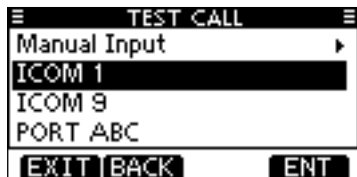

▨ About Manual Inputting:

Enter a desired address ID in the following way:

- Select a desired number using Dial, or [▲]/[▼]/[◀]/[▶].
- Push [ENT] or Dial to set it.
- To move the cursor, select either arrow, “←” or “→,” then push [ENT] or Dial.
- The first digit is specified as ‘0’ for a Group ID. If a Group ID is entered, an error beep sounds after pushing [FINISH].
- The first two digits are ‘0’ for any Coast station ID.



- ③ A confirmation screen appears.
 - Confirm the call contents.

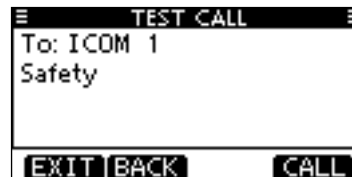

- ④ Push [CALL] to transmit the Test call.
- If Channel 70 is busy, the transceiver stands by until the channel becomes clear.



- ⑤ After the Test call has been transmitted, the following screen is displayed.

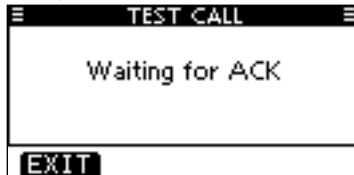

- ⑥ When the acknowledgement call is received, beeps sound and the following screen is displayed.



- ⑦ Push [ALARM OFF] to stop the beeps, and then the screen as shown below is displayed.



- ⑧ Push [EXIT] to return to the normal operating mode.

7 DSC OPERATION

◇ Transmitting a Test Acknowledgement call

When the “TEST ACK” in DSC settings is set to ‘Auto TX’ (p. 66), the transceiver automatically transmits a reply call when receiving a Test call.

Quick ACK:

- ① When a Test call is received, beeps sound and the screen shown below is displayed.

Push [ALARM OFF] to stop the beeps.



- ② Push [ACK].

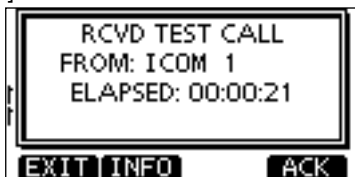

- Push [INFO] to display the Test call information.
Push [BACK] to return to the previous screen, or push [ACK].



- ③ The Test ACK confirmation screen is displayed.
Push [CALL] to transmit the acknowledgement call.



- ④ While transmitting the acknowledgement call, the screen shown below is displayed, and then returns to the normal operating mode.



Manual ACK:

- ① Enter "TEST ACK" in the DSC CALLS menu.

◀MENU> ⇨ ◀DSC Calls> ⇨ ◀Test ACK>
 (Push [MENU]) (Rotate Dial, then push [ENT].)

- If no Test call has been received, the "TEST ACK" item will not be displayed.



- ② Select a desired Test call to reply to, using Dial or [▲]/[▼], then push Dial or [ENT].

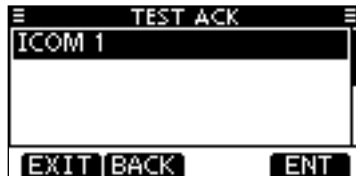

- ③ The Test ACK confirmation screen is displayed. Push [CALL] to transmit the acknowledgement call.



- ④ While transmitting the acknowledgement call, the screen shown below is displayed, and then returns to the normal operating mode.



7 DSC OPERATION

◇ Transmitting a Position Reply call

Transmit a Position Reply call when a Position Request call is received.

When the "POSITION ACK" in DSC Settings is set to 'Auto TX' (p. 66), the transceiver automatically transmits a reply call when receiving a Position Request call.

Quick Reply:

- ① When a Position Request call is received, beeps sound and the screen shown below is displayed.
Push [ALARM OFF] to stop the beeps.



- ② Push [ACK].



- Push [INFO] to display the Position Request call information.
Push [BACK] to return to the previous screen, or push [ACK].



- ③ The Position Reply confirmation screen is displayed.
Push [CALL] to transmit the reply call.

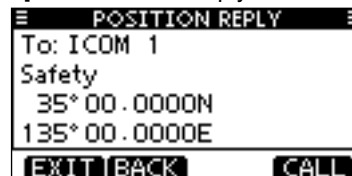

- ④ While transmitting the reply call, the screen shown below is displayed, and then returns to the normal operating mode.



Manual Reply:

- ① Enter "POSITION REPLY" in the DSC CALLS menu.

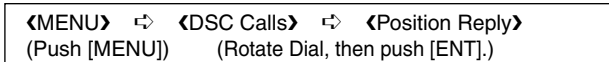

- If no Position Request call has been received, the "POSITION REPLY" item will not be displayed.



- ② Select a desired Position Request call to reply to, using Dial or [▲]/[▼], then push Dial or [ENT].

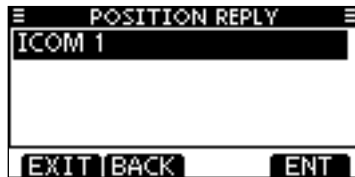

- ③ The Position Reply call confirmation screen is displayed. Push [CALL] to transmit the acknowledgement call.



- ④ While transmitting the reply call, the screen shown below is displayed, and then returns to the normal operating mode.



When no GPS receiver is connected, and both position and time have been manually programmed, the screen shown below appears. Edit your latitude and longitude position and UTC time as follows:



- Push [CHG], then edit your latitude and longitude position and UTC time.
 - Select a desired number using Dial, or [▲]/[▼]/[◀]/[▶].
 - Push [ENT] or Dial to set it.
 - To move the cursor, select either arrow, "←" or "→," then push [ENT] or Dial.
 - Select N (North latitude) or S (South latitude) when the cursor is on the 'N' or 'S' position.
 - Select W (West longitude) or E (East longitude) when the cursor is on the 'W' or 'E' position.

7 DSC OPERATION

◇ Transmitting a Position Report Reply call

Transmit a Position Report Reply call when a Position Report Request call is received.

Quick Reply:

- ① When a Position Report Request call is received, beeps sound and the screen as shown below is displayed.
Push [ALARM OFF] to stop the beeps.



- ② Push [ACK].

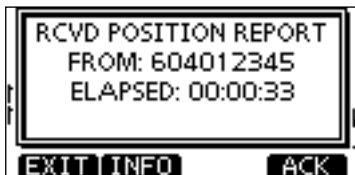

- Push [INFO] to display the Position Report Request call information.
Push [BACK] to return to the previous screen, or push [ACK].

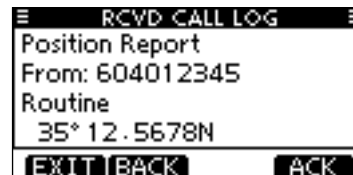

- ③ The Position Report Reply confirmation screen is displayed.
Push [CALL] to transmit the reply call.

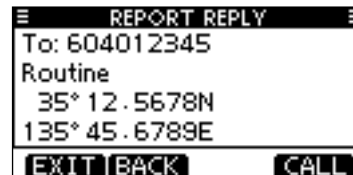

- ④ While transmitting the reply call, the screen shown below is displayed, and then returns to the normal operating mode.



Manual Reply:

- ① Enter "POSITION REPORT REPLY" in the DSC CALLS menu.

◀MENU> ⇄ ◀DSC Calls> ⇄ ◀Position Report Reply>
 (Push [MENU]) (Rotate Dial, then push [ENT].)

- If no Position Report Request call has been received, the "POSITION REPORT REPLY" item will not be displayed.



- ② Select a desired Position Report Request call to reply to, using Dial or [▲]/[▼], then push Dial or [ENT].



- ③ The Position Report Reply call confirmation screen is displayed. Push [CALL] to transmit the acknowledgement call.



- ④ While transmitting the reply call, the screen shown below is displayed, and then returns to the normal operating mode.



7 DSC OPERATION

◇ Transmitting a Polling Reply call

Transmit a Polling Reply call when a Polling Request call is received.

When the "POSITION ACK" in DSC Settings is set to 'Auto TX' (p. 66), the transceiver automatically transmits a reply call when receiving a Polling Request call.

Quick Reply:

- ① When a Polling Request call is received, beeps sound and the screen as shown below is displayed.
Push [ALARM OFF] to stop the beeps.

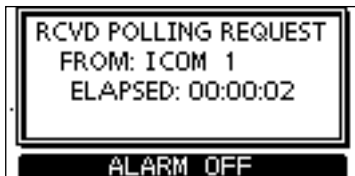

- ② Push [ACK].

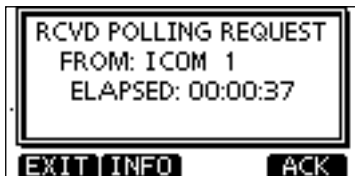

- Push [INFO] to display the Polling Request call information. Push [BACK] to return to the previous screen, or push [ACK].



- ③ The Polling Reply confirmation screen is displayed. Push [CALL] to transmit the reply call.

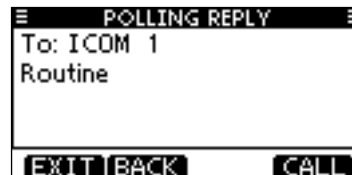

- ④ While transmitting the reply call, the screen shown below is displayed, and then returns to the normal operating mode.



Manual Reply:

- ① Enter “POLLING REPLY” in the DSC CALLS menu.

◀MENU> ⇄ <DSC Calls> ⇄ <Polling Reply>
 (Push [MENU]) (Rotate Dial, then push [ENT].)

- If no Polling Request call has been received, the “POLLING REPLY” item will not be displayed.

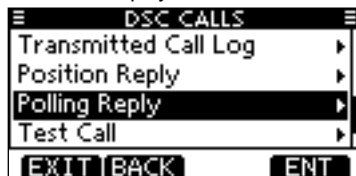

- ② Select a desired Polling Request call to be replied, using Dial or [▲]/[▼], then push Dial or [ENT].

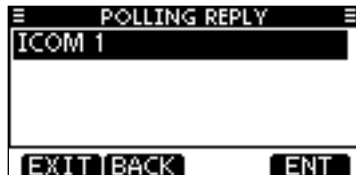

- ③ The Polling Reply call confirmation screen is displayed. Push [CALL] to transmit the acknowledgement call.

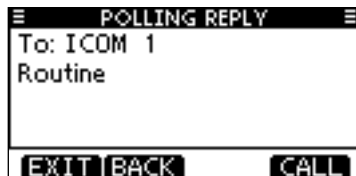

- ④ While transmitting the reply call, the screen shown below is displayed, and then returns to the normal operating mode.



■ Receiving DSC calls

◇ Receiving a Distress Call

When a Distress Call is received:

- The emergency alarm sounds for 2 minutes.
- “RCVD DISTRESS” pops up and the LCD backlight blinks.

- ① Push [ALARM OFF] to stop the alarm and the blinking backlight.



- ② Push a softkey to select your desired action.



[IGN]

- Push to return to the normal operating mode.
 - The transceiver exits the DSC mode.
 - By pushing [PTT], the transceiver also exits the DSC mode.
 - “✉” continues to blink and the Call is stored in the Received Call Log.

[INFO]

- Push to display the Received call information. (p. 64)

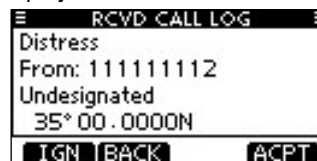

[ACPT]

- Push to accept the call.
 - And then, push [CH 16] to switch the operating channel to Channel 16, and then monitor it, as a coast station may require assistance.
 - If you haven't pushed [CH 16] within 10 seconds, the operating channel automatically switches to Channel 16. (p. 67)



↓ Push

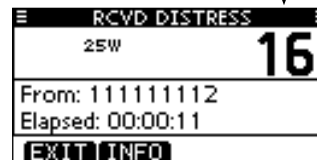

◇ Receiving a Distress Acknowledgement

When a Distress Acknowledgement sent to another ship is received:

- The emergency alarm sounds for 2 minutes.
- “RCVD DISTRESS ACK” pops up and the LCD backlight blinks.

① Push [ALARM OFF] to stop the alarm and the blinking backlight.



② Push a softkey to select your desired action.

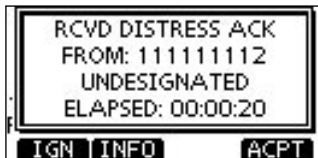

[IGN]

- Push to return to the normal operating mode.
 - The transceiver exits the DSC mode.
 - By pushing [PTT], the transceiver also exits the DSC mode.
 - “” continues to blink and the Call is stored in the Received Call Log.

[INFO]

- Push to display the Received call information. (p. 64)



[ACPT]

- Push to accept the call.
 - And then, push [CH 16] to switch the operating channel to Channel 16, and then monitor it, as a coast station may require assistance.
 - If you haven't pushed [CH 16] within 10 seconds, the operating channel automatically switches to Channel 16. (p. 67)



↓ Push

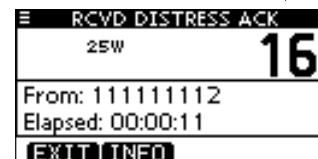

7 DSC OPERATION

◇ Receiving a Distress Relay Call

When a Distress Relay call is received:

- The emergency alarm sounds for 2 minutes.
- “RCVD DISTRESS RELAY” pops up and the LCD backlight blinks.

- ① Push [ALARM OFF] to stop the alarm and the blinking backlight.



- ② Push a softkey to select your desired action.



[IGN]

- Push to return to the normal operating mode.
 - The transceiver exits the DSC mode.
 - By pushing [PTT], the transceiver also exits the DSC mode.
 - “” continues to blink and the Call is stored in the Received Call Log.

[INFO]

- Push to display the Received call information. (p. 64)

[ACPT]

- Push to accept the call.

And then, push [CH 16] to switch the operating channel to Channel 16, and then monitor it, as a coast station may require assistance.

- If you haven't pushed [CH 16] within 10 seconds, the operating channel automatically switches to Channel 16. (p. 67)

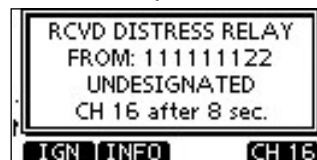

↓ Push

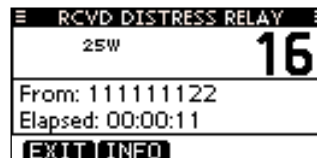

◇ Receiving a Distress Relay Acknowledgement

When a Distress Relay Acknowledgement is received:

- The emergency alarm sounds for 2 minutes.
- “RCVD DIST RELAY ACK” pops up and the LCD backlight blinks.

- ① Push [ALARM OFF] to stop the alarm and the blinking backlight.



- ② Push a softkey to select your desired action.



[IGN]

- Push to return to the normal operating mode.
 - The transceiver exits the DSC mode.
 - By pushing [PTT], the transceiver also exits the DSC mode.
 - “” continues to blink and the Call is stored in the Received Call Log.

[INFO]

- Push to display the Received call information. (p. 64)

[ACPT]

- Push to accept the call.
 - And then, push [CH 16] to switch the operating channel to Channel 16, and then monitor it, as a coast station may require assistance.
 - If you haven't pushed [CH 16] within 10 seconds, the operating channel automatically switches to Channel 16. (p. 67)

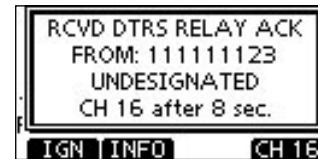

↓ Push

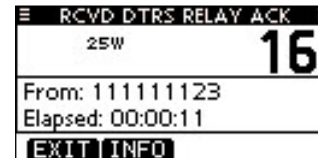

7 DSC OPERATION

◇ Receiving an Individual Call

When an Individual Call is received:

- The alarm sounds for 2 minutes.
- “RCVD INDIVIDUAL CALL” pops up. The LCD backlight may blink for 2 minutes, depending on the received Category.

① Push [ALARM OFF] to stop the alarm and the blinking backlight.

- If [ALARM OFF] is not pushed within 2 minutes, the next screen may appear, depending on the received Category.



② Push a softkey to select your desired action.



[IGN]

- Push to ignore the Call and return to the normal operating mode.
 - The transceiver exits the DSC mode.
 - The Call is stored in the Received Call Log.
 - “☑” continues to blink and the Call is stored in the Received Call Log.

[INFO]

- Push to display the Received call information. (p. 65)

[ACK]

- Push to display the “INDIVIDUAL ACK” screen to reply to the Call, and select the channel specified by the calling station for voice communication, depending on your situation. See page 30 for details of the Individual Acknowledgement procedure.



When “INDIVIDUAL ACK” is set to “Auto ACK (Unable),” the transceiver automatically replies to the Call. In that case, both the TX and RX calls are stored in the Transmitted and Received Call Logs.

◇ Receiving a Group Call

When a Group Call is received:

- ➔ The alarm sounds for 2 minutes.
- ➔ “RCVD GROUP CALL” pops up. The LCD backlight may blink for 2 minutes, depending on the received Category.

- ① Push [ALARM OFF] to stop the alarm and the blinking backlight.
 - If [ALARM OFF] is not pushed within 2 minutes, the next screen may appear, depending on the received Category.



- ② Push a softkey to select your desired action.



[IGN]

- ➔ Push to ignore the Call and return to the normal operating mode.
 - The transceiver exits the DSC mode.
 - “☑” continues to blink and the Call is stored in the Received Call Log.

[INFO]

- ➔ Push to display the Received call information. (p. 65)

[ACPT]

- ➔ Push to monitor the channel specified by the calling station (Example: 08) for an announcement from the calling station.

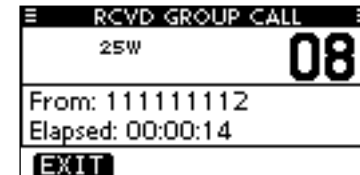

7 DSC OPERATION

◇ Receiving an All Ships Call

When an All Ships Call is received:

- The alarm sounds for 2 minutes.
- “RCVD ALL SHIPS CALL” pops up. The LCD backlight may blink for 2 minutes, depending on the received Category.

- ① Push [ALARM OFF] to stop the alarm and the blinking backlight.
 - If [ALARM OFF] is not pushed within 2 minutes, the next screen may appear, depending on the received Category.



- ② Push a softkey to select your desired action.



[IGN]

- Push to ignore the Call and return to the normal operating mode.
 - The transceiver exits the DSC mode.
 - “☑” continues to blink and the Call is stored in the Received Call Log.

[INFO]

- Push to display the Received call information. (p. 65)

[ACPT]

- Push to monitor the channel specified by the calling station (Example: 16) for an announcement from the calling station.

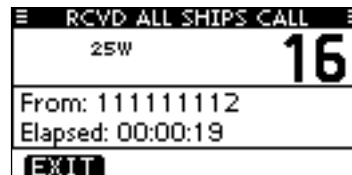

◇ Receiving a Geographical Area Call

When a Geographical Area Call (for the area you are in) is received:

- ➔ The alarm sounds for 2 minutes.
- ➔ “RCVD GEOGRAPHICAL CALL” pops up. The LCD backlight may blink for 2 minutes, depending on the received Category.

- ① Push [ALARM OFF] to stop the alarm and the blinking backlight.
 - If [ALARM OFF] is not pushed within 2 minutes, the next screen may appear, depending on the received Category.



- ② Push a softkey to select your desired action.



[IGN]

- ➔ Push to ignore the Call and return to the normal operating mode.
 - The transceiver exits the DSC mode.
 - “☒” continues to blink and the Call is stored in the Received Call Log.

[INFO]

- ➔ Push to display the Received call information. (p. 65)

[ACPT]

- ➔ Push to monitor the channel specified by the calling station (Example: 08) for an announcement from the calling station.

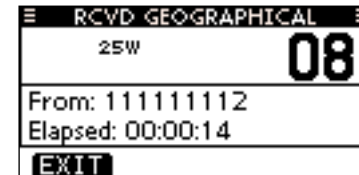

When no GPS receiver is connected or if there is a problem with the connected receiver, all Geographical Area Calls are received, regardless of your position.

7 DSC OPERATION

◇ Receiving a Position Request Call

When a Position Request Call is received:

- The alarm sounds for 2 minutes.
- “RCVD POS REQUEST” pops up. The LCD backlight blinks for 2 minutes.

- ① Push [ALARM OFF] to stop the alarm and the blinking backlight.
 - If [ALARM OFF] is not pushed within 2 minutes, the next screen may appear, depending on the received Category.



- ② Push a softkey to select your desired action.



[IGN]

- Push to ignore the Call and return to the normal operating mode.
 - The transceiver exits the DSC mode.
 - “✉” continues to blink and the Call is stored in the Received Call Log.

[INFO]

- Push to display the Received call information. (p. 65)

[ACK]

- Push to display the “POSITION REPLY” screen and send a reply to the Call. (p. 45)



When “POSITION ACK” is set to “Auto TX,” the transceiver automatically replies to the Call. In that case, both the TX and RX calls are stored in the Transmitted and Received Call Logs.

◇ Receiving a Position Report Call

When a Position Report Call is received:

- ➔ The alarm sounds for 2 minutes.
- ➔ “RCVD POSITION REPORT” pops up. The LCD backlight blinks for 2 minutes.

- ① Push [ALARM OFF] to stop the alarm and the blinking backlight.
 - If [ALARM OFF] is not pushed within 2 minutes, the next screen may appear, depending on the received Category.



- ② Push a softkey to select your desired action.



[EXIT]

- ➔ Push to ignore the Call and return to the normal operating mode.
 - The transceiver exits the DSC mode.
 - “☑” continues to blink and the Call is stored in the Received Call Log.

[INFO]

- ➔ Push to display the Received call information. (p. 65)

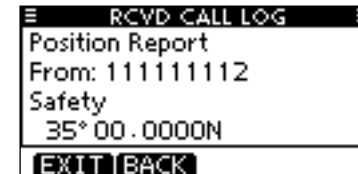

7 DSC OPERATION

◇ Receiving a Polling Request call

When a Polling Request call is received:

- The alarm sounds for 2 minutes.
- “RCVD POLLING REQUEST” pops up. The LCD backlight blinks for 2 minutes.

- ① Push [ALARM OFF] to stop the alarm and the blinking backlight.
 - If [ALARM OFF] is not pushed within 2 minutes, the next screen may appear, depending on the received Category.

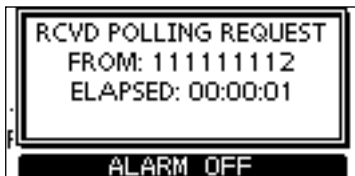

- ② Push a softkey to select your desired action.

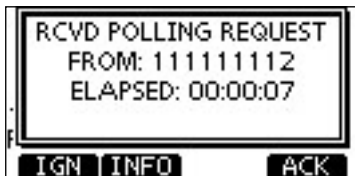

[IGN]

- Push to ignore the Call and return to the normal operating mode.
 - The transceiver exits the DSC mode.
 - “✉” continues to blink and the Call is stored in the Received Call Log.

[INFO]

- Push to display the Received call information. (p. 65)

[ACK]

- Push to display the “POLLING REPLY” screen to reply to the Call. (p. 49)

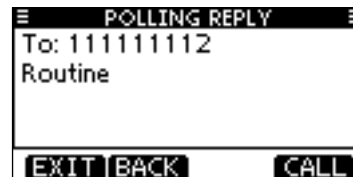

/// When “POSITION ACK” is set to “Auto TX,” the transceiver automatically replies to the Call. In that case, both the TX and RX calls are stored in the Transmitted and Received Call Logs.

◇ Receiving a Test Call

When a Test Call is received:

- The alarm sounds for 2 minutes.
- “RCVD TEST CALL” pops up. The LCD backlight blinks for 2 minutes.

- ① Push [ALARM OFF] to stop the alarm and the blinking backlight.
 - If [ALARM OFF] is not pushed within 2 minutes, the next screen may appear, depending on the received Category.



- ② Push a softkey to select your desired action.



[IGN]

- Push to ignore the Call and return to the normal operating mode.
 - The transceiver exits the DSC mode.
 - “✉” continues to blink and the Call is stored in the Received Call Log.

[INFO]

- Push to display the Received call information. (p. 65)

[ACK]

- Push to display the “TEST ACK” screen to reply to the Call. (p. 43)

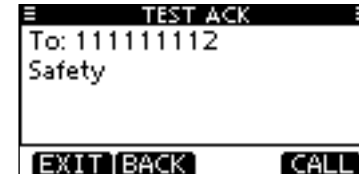

When “TEST ACK” is set to “Auto TX,” the transceiver automatically replies to the Call. In that case, both the TX and RX calls are stored in the Transmitted and Received Call Logs.

7 DSC OPERATION

◇ Receiving a Test Acknowledgement Call

When a Test Acknowledgement Call is received:

- The alarm sounds for 2 minutes.
- “RCVD TEST ACK” pops up. The LCD backlight blinks for 2 minutes.

- ① Push [ALARM OFF] to stop the alarm and the blinking backlight.
 - If [ALARM OFF] is not pushed within 2 minutes, the next screen may appear, depending on the received Category.



- ② Push a softkey to select your desired action.

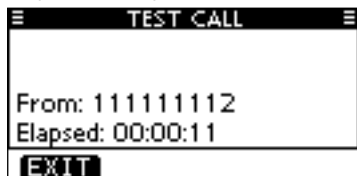

[EXIT]

- Push to return to the normal operating mode.
 - The transceiver exits the DSC mode.
 - “✉” continues to blink and the Call is stored in the Received Call Log.

■ Received Call log

The transceiver automatically stores up to 50 distress messages and 50 other messages, and they can be used as a supplement to your logbook.

- While in the normal operating mode, “✉” blinks in the upper right corner of the LCD when there is an unread DSC message.

◇ Distress message

- ① Push [LOG] to enter “RCVD CALL LOG” in the DSC CALLS menu, or you can enter it through the Menu screen.

◀[MENU]▶ ▶[DSC Calls]▶ ▶[Received Call Log]
(Push [MENU]) (Rotate Dial, then push [ENT].)

- ② Push [▲] or [▼] to select “Distress,” then push [ENT].
 - The Distress messages are stored in “Distress.”
 - “✉” appears when there are unread DSC messages.
 - “📁” appears when there are no unread DSC messages.
 - No icon appears when there are no DSC messages.



- ③ Push [▲] or [▼] to select the desired item, then push [ENT].

- The message in the unopened file has not been read.

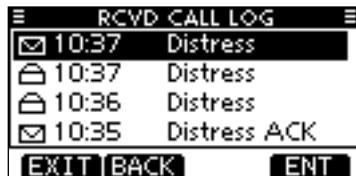

- ④ Rotate Dial to scroll the DSC message contents.



- ⑤ To delete the displayed DSC message, push [DEL].
 - The confirmation screen appears, then push [OK] to delete.
- ⑥ Push [EXIT] to return to the normal operating mode.

◆ Other messages

- ① Push [LOG] to enter “RCVD CALL LOG” in the DSC CALLS menu, or you can enter it through the Menu screen.

◀MENU▶ ⇔ ◀DSC Calls▶ ⇔ ◀Received Call Log▶ (Push [MENU]) (Rotate Dial, then push [ENT].)

- ② Push [▲] or [▼] to select “Others,” then push [ENT].
 - The messages other than the Distress are stored in “Others.”
 - “☑” appears when there are unread DSC messages.
 - “📁” appears when there are no unread DSC messages.
 - No icon appears when there are no DSC messages.

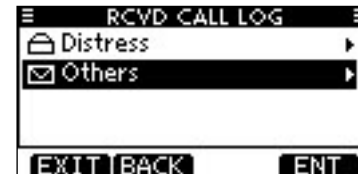

- ③ Push [▲] or [▼] to select the desired item, then push [ENT].
 - The message in the unopened file has not been read.

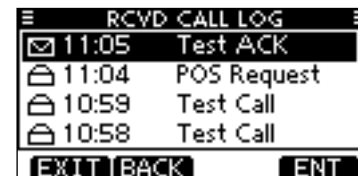

☰ Continued on the next page

7 DSC OPERATION

■ Received Call log (Continued)

④ Rotate Dial to scroll the DSC message contents.

- The stored message has various information, depending on the DSC call type.



⑤ To delete the displayed DSC message, push [DEL].

- The confirmation screen appears, then push [OK] to delete.

⑥ Push [EXIT] to return to the normal operating mode.

■ Transmitted Call log

The transceiver automatically stores up to 50 transmitted calls, and the logs can be used as a supplement to your log-book.

① Enter "TX CALL LOG" in the DSC CALLS menu.

⟨MENU⟩ ⇄ ⟨DSC Calls⟩ ⇄ ⟨Transmitted Call Log⟩
(Push [MENU]) (Rotate Dial, then push [ENT].)

② Push [▲] or [▼] to select the desired item, then push [ENT].



③ Rotate Dial to scroll the DSC message contents.



④ To delete the displayed DSC message, push [DEL].

- The confirmation screen appears, then push [OK] to delete.

⑤ Push [EXIT] to return to the normal operating mode.

■ DSC Settings

- ◇ Position Input (See page 23)
- ◇ Add Individual ID/Group ID (See pages 20, 21)
- ◇ Delete Individual ID/Group ID (See page 22)

◇ Automatic Acknowledgement

These items set the Automatic Acknowledgement function to “Auto TX” or “Manual TX.”

When an Individual, Position Request, Polling Request or Test Call is received, the transceiver automatically transmits an Individual Acknowledgement, Position Reply, Polling Reply or Test Acknowledgement Call, respectively.

When “INDIVIDUAL ACK” is set to “Auto TX,” the transceiver automatically transmits the Acknowledgment call including “Unable to Comply” (No Reason Given) after receiving the Individual call.

- ① Enter either “INDIVIDUAL ACK,” “POSITION ACK” or “TEST ACK” in the DSC Settings menu.

- | |
|---------------------------------------------------------------------------------------------|
| ◀MENU▶ ⇄ ▶DSC Settings▶ ⇄ ▶Individual ACK▶
(Push [MENU]) (Rotate Dial, then push [ENT].) |
| ▶DSC Settings▶ ⇄ ▶Position ACK▶ |
| ▶DSC Settings▶ ⇄ ▶Test ACK▶ |

- ② Rotate Dial to select “Auto TX” or “Manual TX,” then push [ENT].
 - Push [BACK] to cancel and return to the DSC Settings menu.



- ③ Push [EXIT] to return to the normal operating mode.

7 DSC OPERATION

◇ Channel 16 Switch function

By regulation, after receiving a Distress call, the transceiver switches the operating channel to Channel 16. However, when this setting is set to “OFF,” the function enables the transceiver to remain on the operating channel, even after receiving a Distress call.

- ① Enter “CH 16 SWITCH” in the DSC Settings menu.

◀MENU▶	↔	◀DSC Settings▶	↔	◀CH 16 Switch▶
(Push [MENU])		(Rotate Dial, then push [ENT].)		

- ② Rotate Dial to set the Channel 16 Switch function to “Auto (No Delay),” “10 Second Delay” or “OFF,” then push [ENT].
- Push [BACK] to cancel and return to the DSC Settings menu.

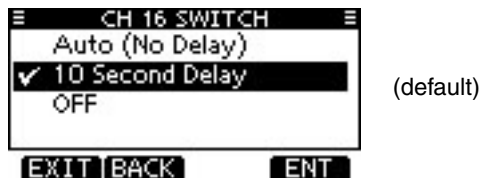

Auto (No Delay) : After receiving a Distress call, and [ACPT] is pushed on the confirmation screen, the transceiver immediately switches to Channel 16.

10 Second Delay : After receiving a Distress call, and [ACPT] is pushed on the confirmation screen, the transceiver remains on the current operating channel for 10 seconds. After that, the transceiver automatically switches to Channel 16. (default)

OFF : Even after receiving a Distress call, the transceiver remains on the operating channel.

- “

③ Push [EXIT] to return to the normal operating mode.

◇ DSC Data Output

Select an option for the DSC Data Output function.
When receiving a DSC call, this function makes the transceiver send the DSC data from its NMEA Output port to a connected device.

- ① Enter “DSC DATA OUTPUT” in the DSC Settings menu.

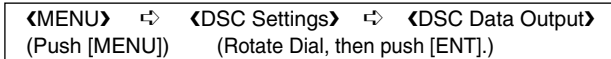

- ② Rotate Dial to set the DSC Data Output function to “All Station,” “List Station” or “OFF,” then push [ENT].
 - Push [BACK] to cancel and return to the DSC Settings menu.

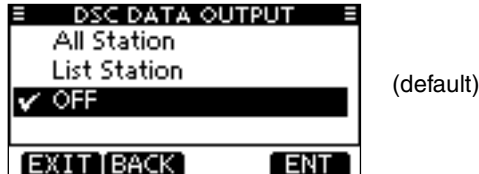

- All Station : Outputs the call from any vessel from the NMEA Output port.
- List Station: Outputs the call from any vessels listed on the Individual ID screen.
- OFF : Does not output any call to the external equipment.

- ③ Push [EXIT] to return to the normal operating mode.

◇ Alarm

Set the Alarm function ON or OFF, depending on the Category or Status.

- ① Enter “ALARM” in the DSC Settings menu.

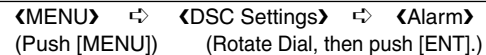

- ② Rotate Dial to select the status, then push [ENT].
 - Push [BACK] to cancel and return to the DSC Settings menu.
 - “Safety,” “Routine,” “Warning,” “Self-Terminate” and “Discrete” are selectable. (default: ON)

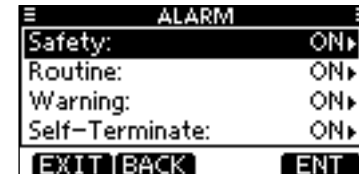

- ③ Rotate Dial to set the Alarm setting to “ON” or “OFF.”
- ④ Push [EXIT] to return to the normal operating mode.

7 DSC OPERATION

◇ Channel 70 Squelch level

Set the squelch level on Channel 70.

The transceiver has 11 squelch levels between 1 (loose squelch) and 10 (tight squelch) and OPEN.

OPEN is completely open.

- ① Enter “CH 70 SQL LEVEL” in the DSC Settings menu.

◀MENU ▶ ⇨ ▶DSC Settings▶ ⇨ ▶CH 70 SQL Level▶
(Push [MENU]) (Rotate Dial, then push [ENT].)

- ② Rotate Dial to adjust the squelch level until the noise just disappears, then push [ENT].

• Push [BACK] to cancel and return to the DSC Settings menu.

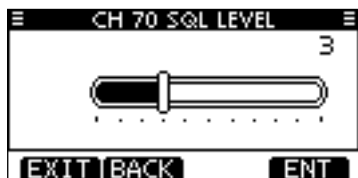

(default)

- ③ Push [EXIT] to return to the normal operating mode.

◇ DSC Loop Test

The DSC loop test function sends transmit DSC signals to the receive AF circuit to compare and check the TX and RX signals at the AF level.

- ① Enter “DSC LOOP TEST” in the DSC Settings menu.

◀MENU ▶ ⇨ ▶DSC Settings▶ ⇨ ▶DSC Loop Test▶
(Push [MENU]) (Rotate Dial, then push [ENT].)

- ② Push [ENT] to start the DSC loop test.

• Push [BACK] to cancel and return to the DSC Settings menu.



• When the transmit DSC and receive DSC signals are matched, “OK” appears.

- ③ Push [EXIT] to return to the normal operating mode.

/// If “NG” appears in step ②, either or both TX and RX DSC circuits has a problem. In that case, you will have to send the transceiver to your nearest dealer for repair.

■ Making an Individual call using an AIS transponder

When the optional MA-500TR CLASS B AIS TRANSPONDER is connected to your transceiver, an individual DSC call can be transmitted to a selected AIS target, without needing to enter the target's MMSI code. In this case, the call type is automatically set to Routine.

See page 84 for connecting instructions.

/// To ensure correct operation of the DSC function, make sure you correctly set the CH70 SQL LEVEL. (p. 69)

Step 1: Transponder's operation

- ① Select a desired AIS target on the plotter, target list or danger list display.
 - You can also go to the next step whenever the detail screen of the AIS target is displayed.
 - Make sure the transceiver is in the normal operating mode. Otherwise, you cannot make an individual DSC call using the transponder.
- ② Push [DSC] to display the voice channel selection screen, and then push [▲] or [▼] to select a desired voice channel*.
 - Voice channels are already preset into the transponder in recommended order.

*When a coast station is selected in step ①, a voice channel will be specified by the coast station, therefore you cannot change the channel. The transponder will display "Voice Channel is specified by the Base station," in this case.



Transponder's display



Transceiver's display

- ③ Push [DSC] to transmit an individual DSC call to the AIS target.
 - If Channel 70 is busy, the transceiver stands by until the channel becomes clear.
 - If the transceiver cannot make the call, the transponder will display "DSC Transmission FAILED".

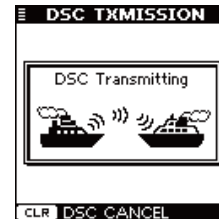

Transponder's display



Transceiver's display

7 DSC OPERATION

- ④ After making the individual DSC call, the transponder will display “DSC Transmission COMPLETED.”
- Push [CLEAR] to return to the screen displayed before you entered the voice channel selection screen in step ②.
 - The transceiver stands by on Channel 70 until an acknowledgement is received.



Transponder's display

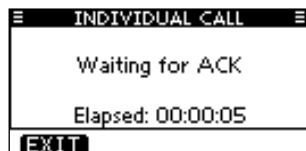

Transceiver's display

Step 2: Transceiver's operation

- ⑤ When the acknowledgement is received, beeps sound.
- ➔ If the acknowledgement 'Able to comply' is received, push [ALARM OFF] to stop the beeps, and then select the intership channel specified in step ②.
 - A different intership channel will be selected if the station you called cannot use the channel.
 - To reply, push [PTT] and speak at a normal voice level.
 - You can check the MMSI code or the name, if programmed, of the AIS target on the display.
 - ➔ If the acknowledgement 'Unable to comply' is received, push [ALARM OFF] to stop the beeps, and then return to the operating channel before you entered the MENU screen.

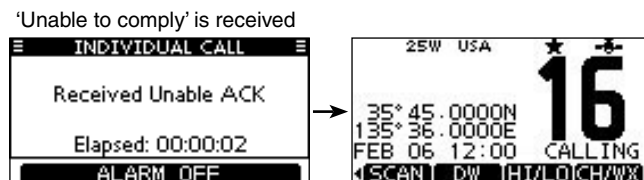
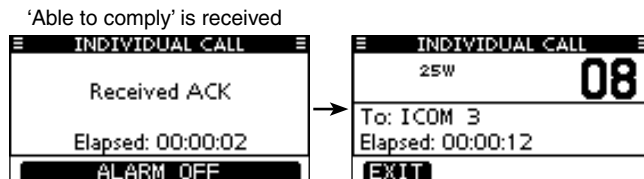

- ⑥ After the communication is finished, push [EXIT] to return to the normal operating mode.

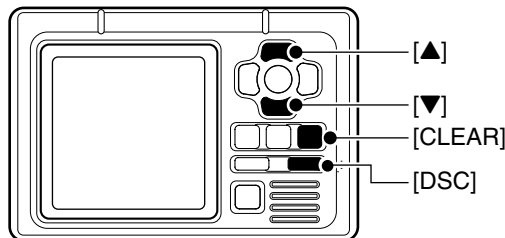

TRANSPONDER

■ Intercom operation

The optional Intercom function allows you to talk between the deck and the cabin. The optional HM-195 COMMAND MICROPHONE is required for Intercom operation.

Connect the HM-195 COMMAND MICROPHONE as described on page 88.

- Transmitting is disabled while using the intercom.
- The received signal is muted while using the intercom.

- ① Hold down [PWR](Dial) to turn ON the power.
 - The command microphone power is automatically turned ON, even if the power is OFF.
- ② Push [INCM] to enter the Intercom mode.

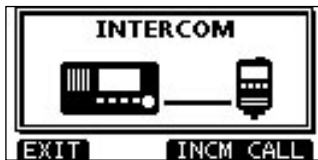

- ③ Hold down [INCM CALL] to sound the intercom beeps.
 - The transceiver and the command microphone sound beeps while holding down [INCM CALL].
 - "CALL" appears.



- ④ After releasing [INCM CALL], hold down [PTT] and speak into the microphone at a normal voice level.
 - "TALK" appears on the caller's display, or "LSTN" appears on the listener's display.
 - To adjust the transceiver's intercom volume level, rotate Dial.
 - To adjust the HM-195's intercom volume level, rotate [VOL/SQ] (Dial) on the HM-195.
- ⑤ After releasing [PTT], you can hear the response through the speaker.



On the caller's display



On the listener's display

- ⑥ To return to the normal operating mode, push [EXIT].

⚡ While in the Intercom mode, the transmit and receive functions are disabled. When the transceiver is transmitting, the Intercom function is disabled.

8 OTHER FUNCTIONS

■ RX Speaker function

The RX Speaker function enables you to hear the received audio on the deck or bridge through a PA speaker. Connect a PA speaker as described on page 83.

- ① Push [RX] to enter the RX Speaker mode.
 - The RX Speaker volume level adjustment screen is displayed.



- ② Rotate Dial or push [▲]/[▼]/[◀]/[▶] to adjust the RX Speaker volume level, and then push [ENT].
 - “RX” appears.

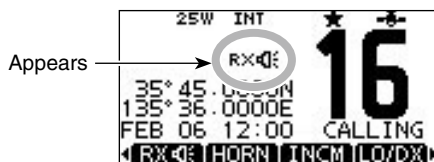

- ③ To return to normal operating mode, push [RX].
 - “RX” disappears.

▨ To adjust the audio output level in the RX Speaker mode, hold down [RX] for 1 second to display the RX Speaker volume level adjustment screen, and then rotate Dial. After adjusting, push [ENT] to set it.

■ PA (Public Address) function

The transceiver has a PA function to make announcements through a PA speaker.

Connect a PA speaker rated at more than 10 W at 10% distortion with a 4 Ω load, as described on page 83.

- Transmitting is disabled while in the PA mode.

- ① Push [PA] to enter the Public Address mode.



- ② Hold down [PTT] and speak at a normal voice level.
 - While holding down [PTT], the screen below is displayed.
 - To adjust the PA volume level, rotate Dial.



- ③ Push [EXIT] to return to normal operating screen.

▨ While in the PA mode, the transmit and receive functions are disabled. When the transceiver is transmitting, the PA function is disabled.

■ Horn function

The Horn function sounds a horn.
Connect a PA speaker as described on page 83.

- ① Push [HORN] to enter the Horn mode.



- ② Hold down [HORN] to sound a horn.
 - While holding down [HORN], the horn sounds, and the screen below is displayed.
 - To adjust the horn volume level, rotate Dial.



- ③ Push [EXIT] to return to the normal operating screen.

/// While in the Horn mode, the transmit and receive functions are disabled. When the transceiver is transmitting, the Horn function is disabled.

Menu screen operation

The Menu screen is used for programming infrequently changed values, function settings or sending DSC calls. In addition to this page, see pages 76 through 82 for details.



Menu lists

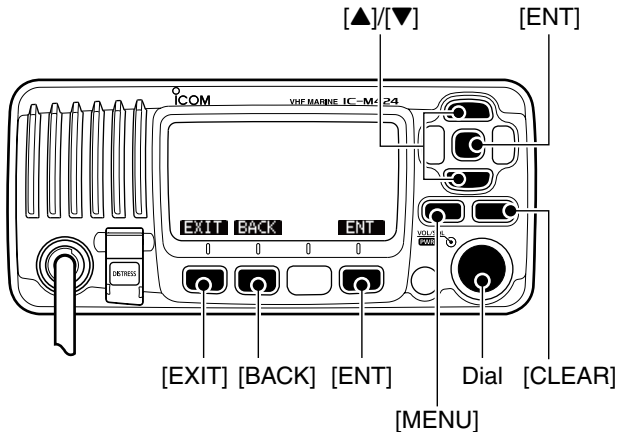

◇ Entering the Menu screen and operation

Example: Set the channel group to “INT.”

- ① Push [MENU].



- ② Rotate Dial or push [▲]/[▼] to select the root item (Radio Settings), and then push [ENT].
- If [▲] or [▼] is continuously held down, the items are sequentially highlighted.



- ③ Rotate Dial or push [▲]/[▼] to select “CHAN Group,” and then push [ENT].



- ④ Rotate Dial or push [▲]/[▼] to select “USA,” and then push [ENT] to set it.
- “✓” is displayed next to “INT.”

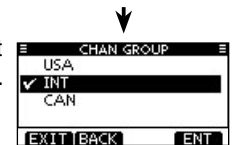

- ⑤ Push [EXIT] to exit the Menu screen.
- Push [CLEAR] or [BACK] to return to the previous screen.

■ Menu screen items

The Menu screen contains the following items.

◇ DSC Calls

Item	Ref.	Item	Ref.
• Individual Call	p. 28	• Transmitted Call Log	p. 65
• Individual ACK*1	p. 30	• Position Request Call*2	p. 35
• Group Call	p. 32	• Position Report Call*2	p. 37
• All Ships Call	p. 34	• Polling Request Call*2	p. 39
• Distress Call	p. 25	• Test Call	p. 41
• Received Call Log	p. 63	• Test ACK*1	p. 44

◇ DSC Settings

Item	Ref.	Item	Ref.
• Position Input*3	p. 23	• CH 16 Switch	p. 67
• Individual ID	p. 20	• DSC Data Output	p. 68
• Group ID	p. 21	• Alarm	p. 68
• Individual ACK	p. 66	• CH 70 SQL Level	p. 69
• Position ACK	p. 66	• DSC Loop Test	p. 69
• Test ACK	p. 66		

*1 Appears only after receiving a corresponding call.

*2 Only U.S.A. and Australian version transceivers.

*3 Appears only when no GPS information is received.

*4 Appears only when the optional HM-195 is connected.

*5 Appears only when a GPS receiver compatible with NMEA0183 ver. 2.0 or 3.01 is connected.

◇ Radio Settings

Item	Ref.	Item	Ref.
• Scan Type	p. 77	• Channel Group	p. 77
• Scan Timer	p. 77	• WX Alert*2	p. 78
• Dual/Tri-Watch	p. 77		

◇ Configuration

Item	Ref.	Item	Ref.
• Backlight	p. 78	• Noise Cancel	p. 80
• Display Contrast	p. 78	• Inactivity Timer	p. 81
• Key Beep	p. 78	• Remote ID	p. 81
• Key Assignment	p. 79	• COMMANDMIC SP*4	p. 82
• UTC Offset	p. 80		

◇ MMSI/GPS Information

The transceiver shows the programmed MMSI code and GPS information*5.

If the code is not programmed, “NO DSC MMSI” is displayed.



■ Radio Settings items

◇ Scan type

The transceiver has two scan types; Normal scan and Priority scan. A Normal scan searches all Favorite channels in the selected channel group. A Priority scan sequentially searches all Favorite channels, while monitoring Channel 16.

(Default: Priority Scan)



◇ Scan resume timer

The scan resume timer can be selected as a pause (OFF) or timer scan (ON). When OFF is selected, the scan pauses until the signal disappears. (Default: OFF)

- **Priority scan** When ON is selected, the scan pauses for 5 seconds and then resumes, even if a signal has been received on any channel other than Channel 16.
- **Normal scan** When ON is selected, the scan pauses for 5 seconds and then resumes, even if a signal has been received on any channel.

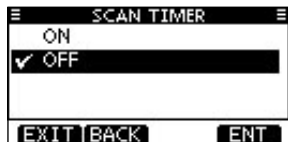

◇ Dual/Tri-watch

This item can be selected as Dualwatch or Tri-watch. (p. 19)
(Default: Dualwatch)



◇ Channel Group

Except for the Europe version, a channel group suitable for your operating area can be selected. Depending on the transceiver version, INT, USA or CAN may be selectable.

(Default: USA)

See page 10 for details.

- The screen below shows the U.S.A. version.



◇ **Weather alert**

A NOAA broadcast station transmits a weather alert tone before important weather information.

“WX ” blinks until the transceiver is operated after the transceiver detects the alert.

- “WX ” appears instead of “WX” when the function is set ON.
(Default: OFF)

ON with Scan : The preprogrammed weather channels are sequentially checked while scanning.

ON : The previously selected (last used) weather channel is checked while scanning.

OFF : The transceiver does not detect a weather alert tone.



■ **Configuration items**

◇ **Backlight**

The function display and keys can be backlit for better visibility under low light conditions.

The backlight can be set to 7 levels and OFF. (Default: 7)

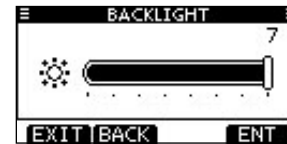

◇ **Display contrast**

This item adjusts the contrast of the LCD in 8 steps.

Level 1 is the lowest contrast, and level 8 is the highest contrast. (Default: 5)

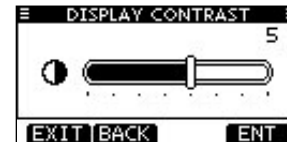

◇ **Key Beep**

You can turn OFF beep tones for silent operation, or you can turn ON the tones to have confirmation beeps sound when a key is pushed.

(Default: ON)

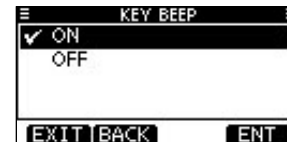

9 MENU SCREEN OPERATION

◇ Key Assignment

Desired functions can be assigned to Dial and the softkeys.

- ① When the “KEY ASSIGNMENT” screen is displayed, rotate Dial or push [▲]/[▼] to select “Dial” or “Softkeys,” and then push [ENT].
- ② Rotate Dial or push [▲]/[▼] to select the desired position, and then push [ENT].
 - To return to the default, select “Set default” and push [ENT].

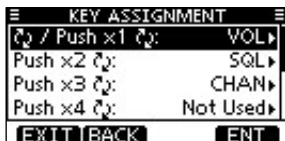

For “Dial” assignment

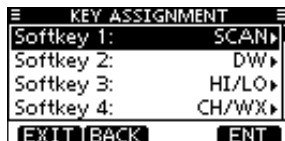

For “Softkeys” assignment

- ③ Rotate Dial or push [▲]/[▼] to select the option, and then push [ENT] to set it.
 - “✓” is displayed next to the selected option.

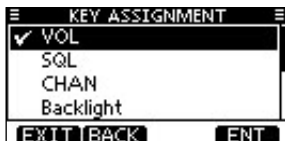

For “Dial” assignment

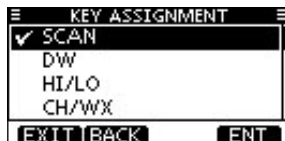

For “Softkeys” assignment*

*[CHAN] appears instead of [CH/WX] only for Chinese version transceiver.

- ④ Push [EXIT] to exit the Menu screen.
 - Push [CLEAR] or [BACK] to return to the previous screen.

• Dial assignment

The Audio volume (VOL), squelch (SQL), channel selection (CHAN) and LCD backlight level (Backlight) functions can be assigned to any one of 4 sequential positions on Dial. Pushing Dial 1 to 4 times sequentially selects the desired function, and rotating Dial adjusts the level or selects a value or number.

For example:

- VOL is assigned the 1st position, and pushing Dial once selects VOL. The VOL screen adjust screen is displayed and rotating Dial adjusts the audio volume.
- CH is assigned to the 3rd position, and pushing Dial three times selects CH. The channel number is displayed and rotating Dial will select the desired channel.

You can assign VOL, SQL, CHAN and Backlight to any one of the 1st, 2nd, 3rd, or 4th sequential positions.

Repeatedly pushing Dial sequentially displays all the functions in the order they are assigned, and skips any functions assigned as Not Used.

• Softkeys assignment

The desired function can be assigned as the softkey function. The assigned function can be used when its key icon is displayed.

See page 3 for details of the assignable key functions.

◇ UTC Offset

Set the offset time between the UTC (Universal Time Coordinated) and your local time to between -14:00 and +14:00 (in 1 minute steps). (Default: 00:00)



◇ Noise Cancel

Set the Noise Cancel function for both receive and transmit.

- ① When the "NOISE CANCEL" screen is displayed, rotate Dial or push [▲]/[▼] to select "RX" or "TX," and then push [ENT].

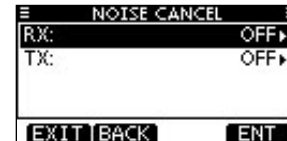

- ② Rotate Dial or push [▲]/[▼] to select the option, and then push [ENT] to set it.
 - "✓" is displayed next to the selected option.
- ③ Push [EXIT] to exit the Menu screen.
 - Push [CLEAR] or [BACK] to return to the previous screen.

9 MENU SCREEN OPERATION

• RX

Turn the receive Noise Cancel function ON or OFF.

OFF : Turns OFF the function. (Default)

- 1 : The Noise Cancel function reduces random noise components in the received signal to approximately one half.
- 2 : The Noise Cancel function reduces random noise components in the received signal to approximately one third.
- 3 : The Noise Cancel function reduces random noise components in the received signal to approximately one tenth.

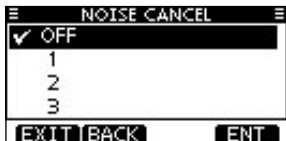

• TX

Turn the transmit Noise Cancel function ON or OFF.

OFF : Turns OFF the function. (Default)

ON : The Noise Cancel function reduces random noise components in the transmitted signal to one third.

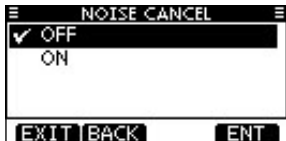

◇ Inactivity Timer

Set the inactivity timer to between 1 and 10 minutes (in 1 minute steps) or OFF for the “Not DSC Related” and “DSC Related” item, and set to between 1 and 15 minutes (in 1 minute steps) or OFF for the “DSC Related” item. The count down alarm sounds 10 seconds before the Inactive timer returns the current screen to the normal operating screen.

- ① When the “INACTIVITY TIMER” screen is displayed, rotate Dial or push [▲]/[▼] to select “Not DSC Related” or “DSC Related,” and then push [ENT].
- ② Rotate Dial or push [▲]/[▼] to select the option, and then push [ENT] to set it.
 - “✓” is displayed next to the selected option.
- ③ Push [EXIT] to exit the Menu screen.
 - Push [CLEAR] or [BACK] to return to the previous screen.

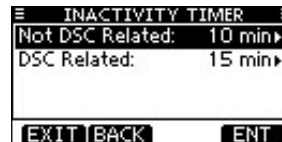

• **Not DSC Related**

When the LCD displays a screen other than the normal operation screen, or one not related to the DSC, and no key operation occurs for this set period, the transceiver automatically returns to the normal operating screen. (Default: 10 min)



• **DSC Related**

When the LCD displays the screen related to the DSC, and no key operation occurs for this set period, the transceiver automatically returns to the normal operating screen. (Default: 15 min)



◇ **Remote ID**

Set a Remote ID number to between 1 and 69. (Default: 15)
The Remote ID is included in the sentence of the Icom original NMEA format.



◇ **COMMANDMIC Speaker**

(Appears only when the optional HM-195 is connected.)

The HM-195's external speaker can be used instead of the internal speaker.

Internal Speaker : Turns ON the internal speaker. (Default)

External Speaker : Turns ON the external speaker.



Regardless of this setting, the supplied microphone's speaker is ON.

10 CONNECTIONS AND MAINTENANCE

■ Connections

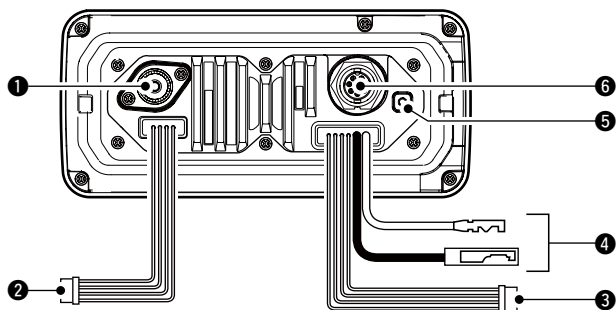

1 ANTENNA CONNECTOR

Connects to a marine VHF antenna cable's PL-259 connector.

CAUTION: Transmitting without an antenna may damage the transceiver.

2 NMEA IN/OUT LEADS

Brown: Talker B (Data-L)

Connects to an NMEA In Negative line of a PC or NMEA0183 ver. 3.01 sentence format DSC, DSE compatible navigation equipment, to receive position data from other ships.

White: Talker A (Data-H)

Connects to an NMEA In Positive line of a PC or NMEA0183 ver. 3.01 sentence format DSC, DSE compatible navigation equipment, to receive position data from other ships.

Green: Listener B (Data-L)

Connects to an NMEA Out Negative line of a GPS receiver for position data.

• A NMEA0183 ver. 2.0 or 3.01 RMC, GGA, GNS, GLL and VTG sentence format compatible GPS receiver is required. Ask your dealer about suitable GPS receivers.

Yellow: Listener A (Data-H)

Connects to an NMEA Out Positive line of a GPS receiver for position data.

• A NMEA0183 ver. 2.0 or 3.01 RMC, GGA, GNS, GLL and VTG sentence format compatible GPS receiver is required. Ask your dealer about suitable GPS receivers.

3 AF OUT LEADS

Blue: External Speaker (+)

Black: External Speaker (-)

Connects to an external speaker.

Orange: Public Address Speaker (+)

Gray: Public Address Speaker (-)

Connects to a PA speaker.

• PA output power: More than 10 W at 10% distortion with a 4 Ω load

NOTE for NMEA In/Out and AF Out leads:

The connectors are attached to keep the leads together. Before connecting to a piece of equipment, you should cut the leads to remove the connector.

4 DC POWER CONNECTOR

Connects to a 13.8 V DC power source.

CAUTION: After connecting the DC power cable, NMEA leads, external speaker leads and PA speaker leads, cover the connector and leads with an adhesive tape, as shown below, to prevent water seeping into the connection.

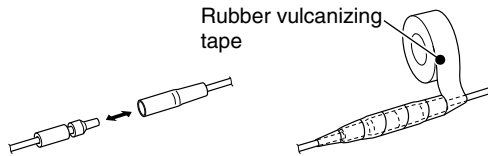

5 GROUND TERMINAL

Connects to a vessel ground to prevent electrical shocks and interference from other equipment occurring. Use a PH M3 × 6 screw (not supplied).

6 COMMAND MICROPHONE JACK

Connects to the optional Command microphone. (p. 88)

◇ Connect to the MA-500TR

Connect the transceiver to the high-density D-Sub 15-pin connector of the MA-500TR using the OPC-2014* cable. After connecting, an Individual DSC call can be made to the AIS target using the transponder without entering the target's MMSI code.

* The OPC-2014 is supplied with the MA-500TR

- **Listener A (Data-H) lead (Yellow):**
Connects to lead 3 of the OPC-2014.
- **Listener B (Data-L) lead (Green):**
Connects to lead 2 of the OPC-2014.
- **Talker A (Data-H) lead (White):**
Connects to lead 5 of the OPC-2014.
- **Talker B (Data-L) lead (Brown):**
Connects to lead 4 of the OPC-2014.

10 CONNECTIONS AND MAINTENANCE

■ Antenna

A key element in the performance of any communication system is the antenna. Ask your dealer about antennas and the best place to mount them.

■ Fuse replacement

One fuse is installed in the supplied DC power cable. If the fuse blows or the transceiver stops functioning, track down the source of the problem, repair it, and replace the damaged fuse with a new one of the proper rating.

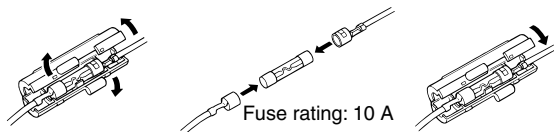

■ Cleaning

If the transceiver becomes dusty or dirty, wipe it clean with a soft, dry cloth.



DO NOT use harsh solvents such as benzine or alcohol, as they will damage transceiver surfaces.

■ Supplied accessories

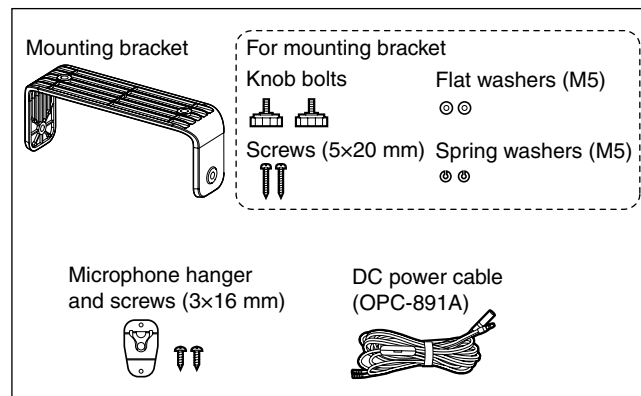

■ Mounting the transceiver

◇ Using the supplied mounting bracket

The universal mounting bracket supplied with your transceiver allows overhead or dashboard mounting.

- ① Mount the bracket securely to a surface which is more than 10 mm thick and can support more than 5 kg using the 2 supplied screws (5 × 20 mm).
- ② Attach the transceiver to the bracket so that the face of the transceiver is at 90° to your line of sight when operating it.

/// **KEEP** the transceiver and microphone at least 1 meter away from the vessel's magnetic navigation compass.

/// **NOTE:** Check the installation angle; the function display may not be easy-to-read at some angles.

• OVERHEAD MOUNTING

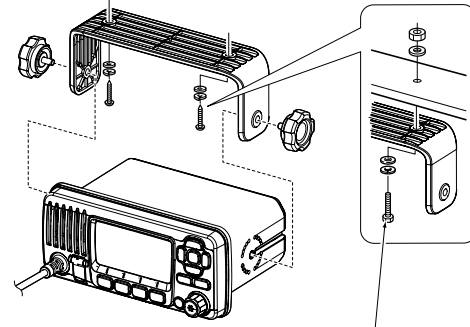

• MOUNTING ON THE BOARD

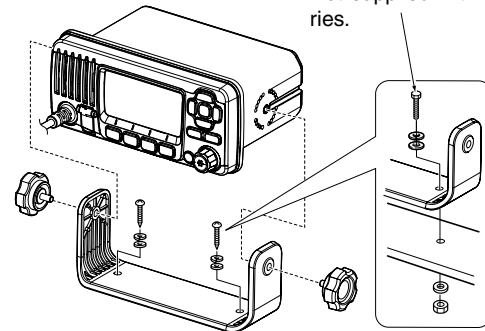

These bolts are shown a mounting example only. Not supplied with accessories.

10 CONNECTIONS AND MAINTENANCE

■ MB-132 installation

An optional MB-132 FLUSH MOUNT is available for mounting the transceiver to a flat surface, such as an instrument panel.

KEEP the transceiver and microphone at least 1 meter away from your vessel's magnetic navigation compass.

- ① Using the template on page 94, carefully cut a hole into the instrument panel, or wherever you plan to mount the transceiver.
- ② Slide the transceiver through the hole, as shown below.

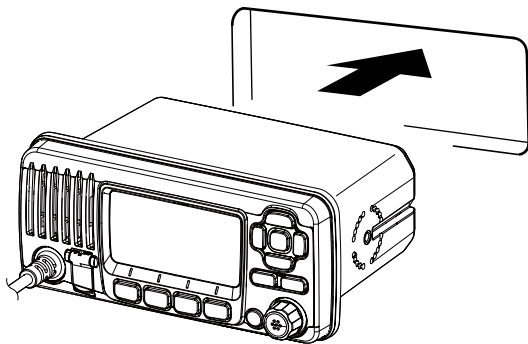

- ③ Attach the clamps on either side of the transceiver with 2 M5 × 8 mm supplied bolts.
 - Make sure that the clamps align parallel to the transceiver body.

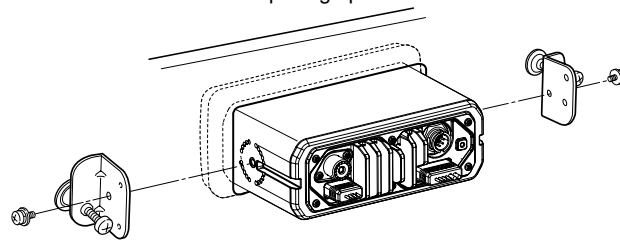

- ④ Tighten the end bolts on the clamps (clockwise) so that the clamps press firmly against the inside of the instrument control panel.
- ⑤ Tighten the locking nuts (counterclockwise) so that the transceiver is securely mounted in position, as shown below.
- ⑥ Connect the antenna and power cable, then return the instrument control panel to its original place.

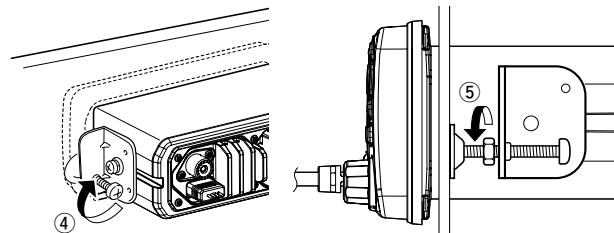

■ Microphone installation

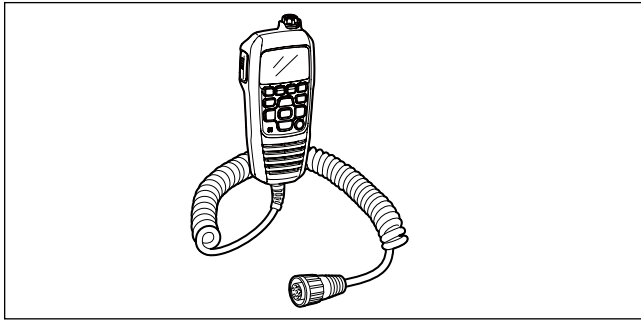

The optional HM-195 should be connected to the transceiver using the supplied OPC-1540 connection cable.

The cable is used to operate from a longer distance. The cable connector can also be installed as a built-in plug on a cabinet or wall.

To operate from even longer distances, the optional 6 meter long OPC-1541 extension cable can be used between the transceiver and the OPC-1540. Up to two OPC-1541 can be added.

◆ Installation

- ① Insert the OPC-1540 cable connector into the command microphone jack, and tighten the nut.
- ② To use the cable connector as a wall socket, install it as described to the right.

- ③ Using the mounting base as a template, carefully mark the holes where the cable and three screws will be fastened.
- ④ Drill holes at these marks.
- ⑤ Install the mounting base using the supplied screws, as shown below.

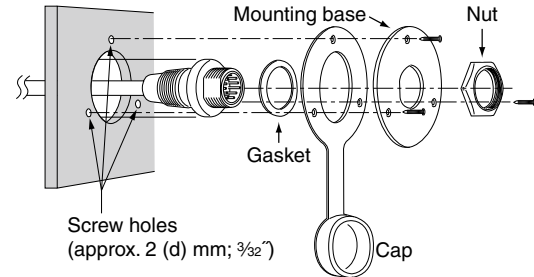

- ⑥ The completed installation should look like this.



10 CONNECTIONS AND MAINTENANCE

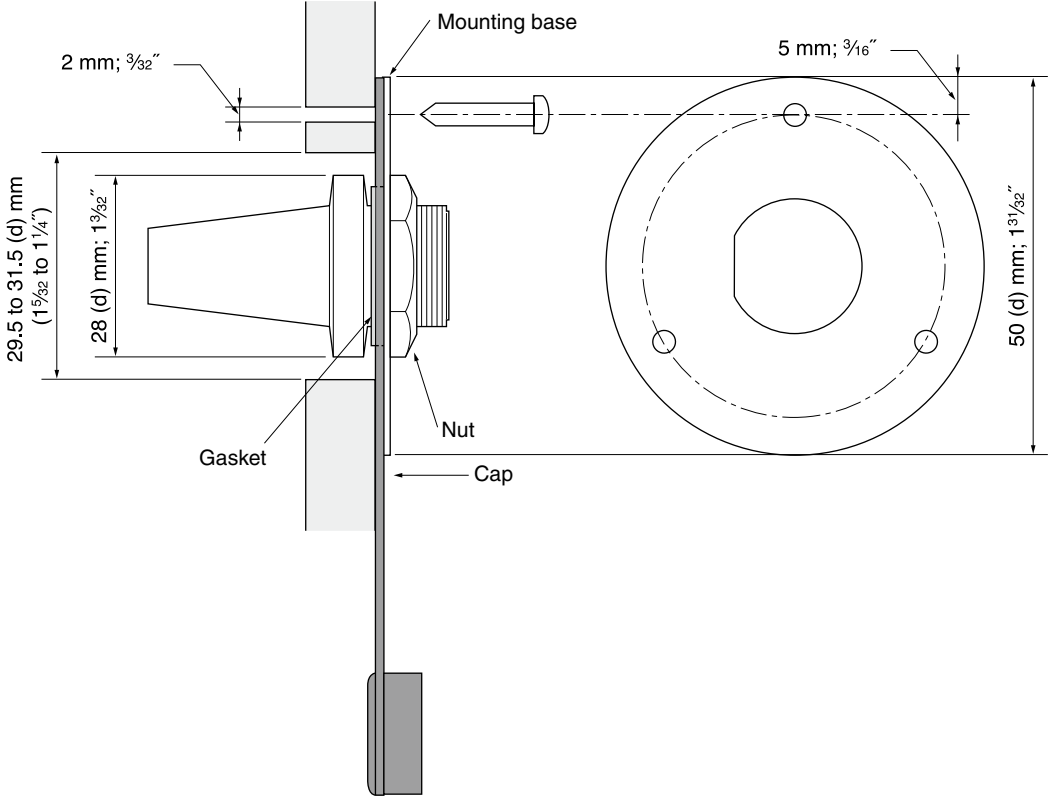

■ Specifications

◇ General

- Frequency coverage
 - USA and AUS versions : Tx 156.025–157.425 MHz
Rx 156.050–163.275 MHz
 - CHN version : Tx 156.025–157.425 MHz
Rx 156.050–162.025 MHz
- Mode : FM (16K0G3E),
DSC (16K0G2B)
- Channel spacing : 25 kHz
- Operating temp. range : –20°C to +60°C; –4°F to +140°F
- Current drain (at 13.8 V) : TX high 5.5 A maximum
Max. audio 5.0 A maximum
- Power supply requirement : 13.8 V DC nominal
(negative ground)
- Frequency stability : ±1.5 kHz (–20°C to +60°C)
- Antenna impedance : 50 Ω nominal
- Dimensions (approximately)
(Projections not included) : 180(W) × 82(H) × 135(D) mm
; 7.1(W) × 3.2(H) × 5.3(D) inches
- Weight (approximately) : 1.2 kg; 2.6 lb

◇ Transmitter

- Output power : 25 W/1 W
- Modulation system : Variable reactance frequency
modulation
- Max. frequency deviation : ±5.0 kHz
- Spurious emissions : Less than –70 dBc (high)
Less than –56 dBc (low)

◇ Receiver

- Receive system : Double conversion
superheterodyne
- Sensitivity (12 dB SINAD) : –13 dBμ (typical)
- Squelch sensitivity : Less than –10 dBμ
- Intermodulation rejection ratio : More than 70 dB
- Spurious response rejection ratio : More than 70 dB
- Adjacent channel selectivity : More than 70 dB
- Audio output power : More than 10 W at 10% distortion with a 4 Ω load

All stated specifications are subject to change without notice or obligation.

11 SPECIFICATIONS AND OPTIONS

◇ Dimensions

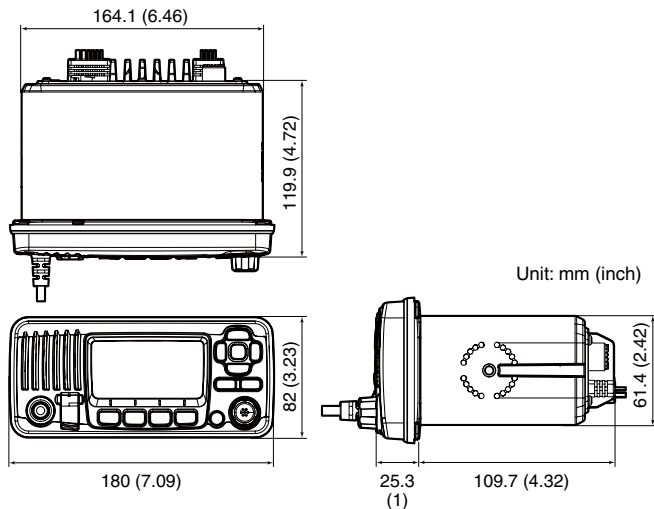

■ Options

- **MB-132** FLUSH MOUNT KIT
To mount the transceiver to a panel.
- **HM-195** COMMANDMICIV™
External microphone-type controller. Provides optional intercom operation. 6 m (20 ft) microphone cable and mounting base included. Black and white colors are available.
- **HM-196** HAND MICROPHONE
Equipped with [▲]/[▼] (channel up/down,) [HI/LO] and [PTT] keys, a speaker and microphone.
- **OPC-1541** MICROPHONE EXTENSION CABLE
6 m (20 feet) microphone extension cable for optional HM-195 COMMANDMICIV™. Up to two OPC-1541 can be connected. Usable length is 18 m (60 ft) maximum.
- **MA-500TR** CLASS B AIS TRANSPONDER
To transmit individual DSC calls to a selected AIS targets.

Approved Icom optional equipment is designed for optimal performance when used with an Icom transceiver. Icom is not responsible for the destruction or damage to an Icom transceiver in the event the Icom transceiver is used with equipment that is not manufactured or approved by Icom.

CHANNEL LIST 12

Channel number		Frequency (MHz)		
USA	INT	CAN	Transmit	Receive
	01	01	156.050	160.650
01A			156.050	156.050
	02	02	156.100	160.700
	03	03	156.150	160.750
03A			156.150	156.150
	04		156.200	160.800
		04A	156.200	156.200
	05		156.250	160.850
05A		05A	156.250	156.250
06	06	06	156.300	156.300
	07		156.350	160.950
07A		07A	156.350	156.350
08	08	08	156.400	156.400
09	09	09	156.450	156.450
10	10	10	156.500	156.500
11	11	11	156.550	156.550
12	12	12	156.600	156.600
13* ²	13	13* ¹	156.650	156.650
14	14	14	156.700	156.700
15* ²	15* ¹	15* ¹	156.750	156.750
16	16	16	156.800	156.800
17* ¹	17	17* ¹	156.850	156.850
	18		156.900	161.500
18A		18A	156.900	156.900
	19		156.950	161.550
19A		19A	156.950	156.950
20	20	20* ¹	157.000	161.600
20A			157.000	157.000

Channel number		Frequency (MHz)		
USA	INT	CAN	Transmit	Receive
	21	21	157.050	161.650
21A		21A	157.050	157.050
		21b	Rx only	161.650
	22		157.100	161.700
22A		22A	157.100	157.100
	23	23	157.150	161.750
23A			157.150	157.150
24	24	24	157.200	161.800
25	25	25	157.250	161.850
		25b	Rx only	161.850
26	26	26	157.300	161.900
27	27	27	157.350	161.950
28	28	28	157.400	162.000
		28b	Rx only	162.000
	60	60	156.025	160.625
	61		156.075	160.675
61A		61A	156.075	156.075
	62		156.125	160.725
		62A	156.125	156.125
	63		156.175	160.775
63A			156.175	156.175
	64	64	156.225	160.825
64A		64A	156.225	156.225
	65		156.275	160.875
65A	65A	65A	156.275	156.275
	66		156.325	160.925
66A	66A	66A* ¹	156.325	156.325
67* ²	67	67	156.375	156.375

Channel number		Frequency (MHz)		
USA	INT	CAN	Transmit	Receive
68	68	68	156.425	156.425
69	69	69	156.475	156.475
70* ³	70* ³	70* ³	156.525	156.525
71	71	71	156.575	156.575
72	72	72	156.625	156.625
73	73	73	156.675	156.675
74	74	74	156.725	156.725
75* ¹	75* ¹	75* ¹	156.775	156.775
76* ¹	76* ¹	76* ¹	156.825	156.825
77* ¹	77	77* ¹	156.875	156.875
	78		156.925	161.525
78A		78A	156.925	156.925
	79		156.975	161.575
79A		79A	156.975	156.975
	80		157.025	161.625
80A		80A	157.025	157.025
	81		157.075	161.675
81A		81A	157.075	157.075
	82		157.125	161.725
82A		82A	157.125	157.125
	83	83	157.175	161.775
83A		83A	157.175	157.175
		83b	Rx only	161.775
84	84	84	157.225	161.825
84A			157.225	157.225
85	85	85	157.275	161.875
85A			157.275	157.275
86	86	86	157.325	161.925

Channel number		Frequency (MHz)		
USA	INT	CAN	Transmit	Receive
86A			157.325	157.325
87	87	87	157.375	161.975
87A			157.375	157.375
88	88	88	157.425	162.025
88A			157.425	157.425

WX channel	Frequency (MHz)	
	Transmit	Receive
1	RX only	162.550
2	RX only	162.400
3	RX only	162.475
4	RX only	162.425
5	RX only	162.450
6	RX only	162.500
7	RX only	162.525
8	RX only	161.650
9	RX only	161.775
10	RX only	163.275

*1 Low power only. *2 Momentary high power. *3 DSC operation only.

NOTE: Simplex channels, 3, 21, 23, 61, 64, 81, 82 and 83 CANNOT be lawfully used by the general public in U.S.A. waters.

13 TROUBLESHOOTING

PROBLEM	POSSIBLE CAUSE	SOLUTION	REF.
The transceiver does not turn ON.	<ul style="list-style-type: none">• Bad connection to the power supply.	<ul style="list-style-type: none">• Check the connection to the transceiver and power supply.	p. 83
Little or no sound comes from the speaker.	<ul style="list-style-type: none">• Squelch level is set too high.• Volume level is set too low.• Speaker has been exposed to water.	<ul style="list-style-type: none">• Set the squelch to the threshold point.• Set the volume to a suitable level.• Remove the water with the AquaQuake function.	p. 15 p. 15 p. 16
Transmitting is impossible, or high power cannot be selected.	<ul style="list-style-type: none">• Some channels are programmed for low power or receive only by regulations.• The output power is set to low.	<ul style="list-style-type: none">• Change channels.• Push [HI/LO] to select high power.	pp. 9, 10, 11 p. 11
Scan does not start.	<ul style="list-style-type: none">• Favorite channels are not programmed.	<ul style="list-style-type: none">• Set the desired channels as Favorite channels.	p. 18
No beep sounds.	<ul style="list-style-type: none">• Beep tones are turned OFF.	<ul style="list-style-type: none">• Turn the beep tones ON in the CONFIGURATION menu.	p. 78
Distress calls cannot be transmitted.	<ul style="list-style-type: none">• MMSI (DSC self ID) code is not programmed.	<ul style="list-style-type: none">• Program the MMSI (DSC self ID) code.	p. 8

TEMPLATE 14

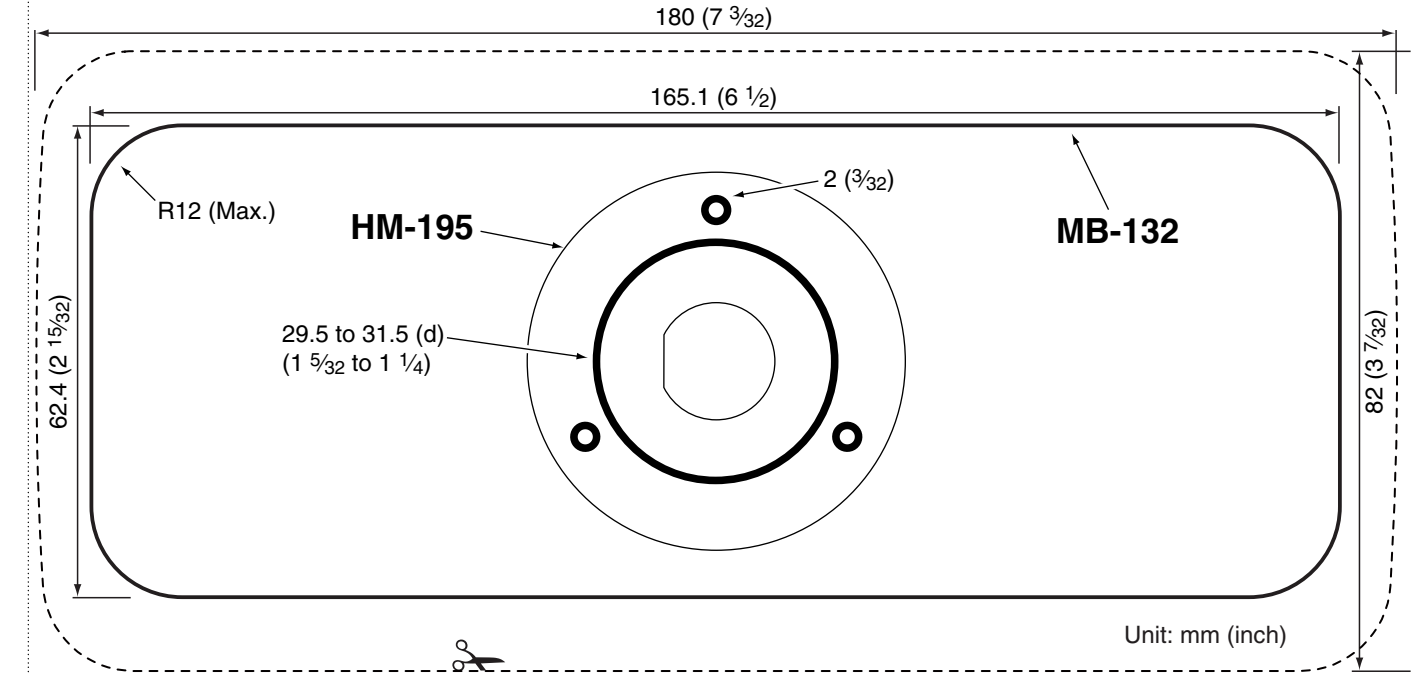

Cut here

13
14

Count on us!

A-7011D-1EX-①
Printed in Japan
© 2012 Icom Inc.

Printed on recycled paper with soy ink.

Icom Inc.

1-1-32 Kamiminami, Hirano-ku, Osaka 547-0003, Japan