

Wiring Diagram

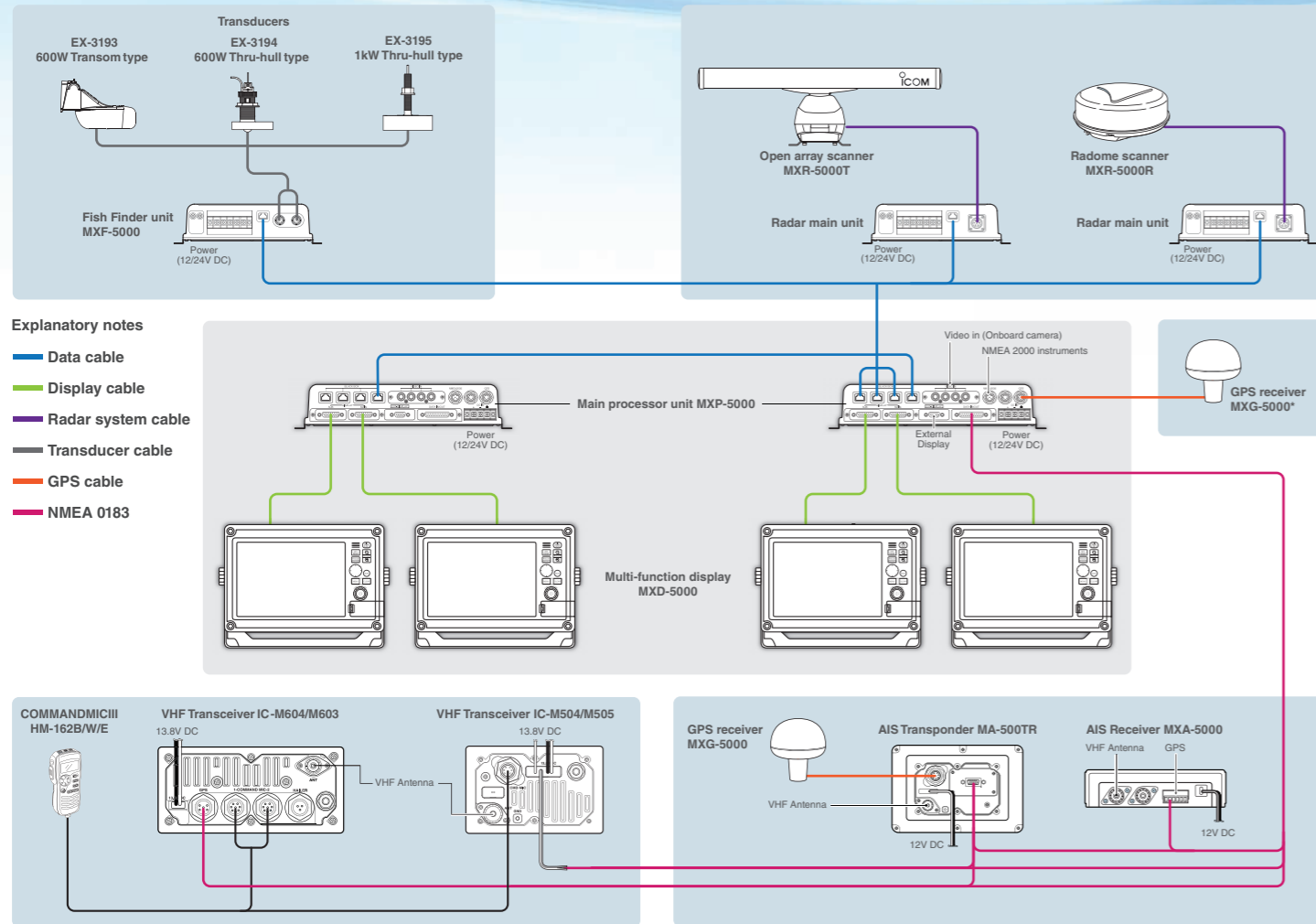

Option Cables



- EX-3187**
Display extension cable
(5m; 16.4ft)
Up to three EX-3187
cables are connectable.
- OPC-1895**
Data cable (20m; 65.6ft)
For connection from MPU to
radar or fish finder and
between MPU and MPU.
- OPC-1929**
Transducer extension cable
(6m; 19.7ft)
- OPC-1077** (20m; 65.6ft)
OPC-1078 (30m; 98.4ft)
Radar system cables for connection
between radar main unit and scanner unit.
OPC-1077 is for MXR-5000R only.

ICOM, ICOM Inc. and the ICOM logo are registered trademarks of ICOM Incorporated (Japan) in the United States, the United Kingdom, Germany, France, Spain, Russia, Japan and/or other countries. MarineCommander and MarineCommander logo are trademarks of ICOM Inc. C-MAP is a trademark of Jeppesen. All other trademarks are the properties of their respective holders. This product includes software (part of tcp_wrappers) developed by the University of California, Berkeley. This product includes software developed by the University of California, Berkeley and its contributors.

ICOM Inc. 1-1-32, Kami-minami, Hirano-ku, Osaka 547-0003, Japan Phone: +81 (06) 6793 5302 Fax: +81 (06) 6793 0013 www.icom.co.jp/world **Count on us!**

ICOM America Inc.

2380 116th Avenue NE,
Bellevue, WA 98004, U.S.A.
Phone : +1 (425) 454-8155
Fax : +1 (425) 454-1509
E-mail : sales@icomamerica.com
URL : <http://www.icomamerica.com>

ICOM Canada

Glenwood Centre #150-6165 Highway 17,
Delta, B.C., V4K 5B8, Canada
Phone : +1 (604) 952-4266
Fax : +1 (604) 952-0090
E-mail : info@icomcanada.com
URL : <http://www.icomcanada.com>

ICOM (Australia) Pty. Ltd.

Unit 1 / 103 Garden Road,
Clayton, VIC 3168 Australia
Phone : +61 (03) 9549 7500
Fax : +61 (03) 9549 7505
E-mail : sales@icom.net.au
URL : <http://www.icom.net.au>

ICOM New Zealand

146A Harris Road, East Tamaki,
Auckland, New Zealand
Phone : +64 (09) 274 4062
Fax : +64 (09) 274 4708
E-mail : inquiries@icom.co.nz
URL : <http://www.icom.co.nz>

ICOM (Europe) GmbH

Communication Equipment
Auf der Krautweide 24
65812 Bad Soden am Taunus, Germany
Phone : +49 (6196) 76685-0
Fax : +49 (6196) 76685-50
E-mail : info@icom-europe.com
URL : <http://www.icomeurope.com>

ICOM Spain S.L.

Ctra. Rubi, No. 88 "Edificio Can Castanyer"
Bajos A 08174, Sant Cugat del Valles,
Barcelona, Spain
Phone : +34 (93) 590 26 70
Fax : +34 (93) 589 04 46
E-mail : icom@icomspain.com
URL : <http://www.icomspain.com>

ICOM (UK) Ltd.

Blacksale House, Altrix Park,
Herne Bay, Kent, CT16 6GZ, U.K.
Phone : +44 (01227) 741741
Fax : +44 (01227) 741742
E-mail : info@icomuk.co.uk
URL : <http://www.icomuk.co.uk>

ICOM France s.a.s.

Zac de la Plaine,
1 Rue Brindjonec des Moulinais, BP 45804,
31505 Toulouse Cedex 5, France
Phone : +33 (5) 61 36 03 03
Fax : +33 (5) 61 36 03 00
E-mail : icom@icom-france.com
URL : <http://www.icom-france.com>

ICOM Polska

81-850 Sopot, ul. 3 Maja 54, Poland
Phone : +48 (58) 550 7135
Fax : +48 (58) 551 0484
E-mail : icompolska@icompolska.pl
URL : <http://www.icompolska.com.pl>

Asia ICOM Inc.

6F No. 68, Sec. 1 Cheng-Teh Road,
Taipei, Taiwan, R.O.C.
Phone : +886 (02) 2559 1899
Fax : +886 (02) 2559 1874
E-mail : sales@asia-icom.com
URL : <http://www.asia-icom.com>

Your local distributor/dealer:

ICOM

MarineCommander™



- Integrated System
- Dual Display
- Simple Installation

Command – Your Way, Communications and Navigation Setup

System overview

MarineCommander™ is Icom's marine navigation system, which integrates various marine modules such as a fish finder, marine radar, AIS and VHF transceiver into the multi-function displays (MFD). Up to Two MFDs can be connected to a main processor unit (MPU) and support separate dual display operation. If connecting two MarineCommander MPUs over a data cable, up to four MFDs can be used and the connected modules (E.g. fish finder, radar) can be shared with the other MFDs.

Affordable Dual Display Connection Up to Four Displays in a System

The MarineCommander allows you to connect two MFDs simultaneously. All connected modules including chart data, fish finder and marine radar can be shared with two MFDs and provide separate operation. The MFD can be installed in up to 20m (65.6ft)* away from the MPU. When connecting two MarineCommanders via a data cable, up to 4 displays can be used and C-MAP™ chart data can be shared in the system.

* Three optional EX-3187 extension cables are required.

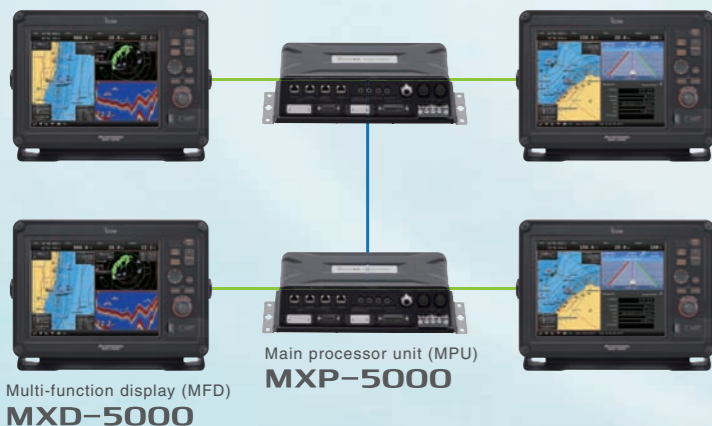

C-MAP™ MAX Compatible

The MarineCommander is compatible with the C-MAP™ MAX chart by JEPPESEN in an SD card format*. The MarineCommander provides quick and fast responding rendering performance. The C-MAP™ MAX chart provides guardian alarm, route-check, perspective view and Port database for your safe and easy navigation.

* Chart data is not supplied from Icom.



Slim Dimensions and Easy Installation

The MFD has 69.2mm (2.7 inch) slim dimensions and is light weight for easy flush mount installation. The MFD has IPX7 submersible construction protecting it from the water intrusion. The MFD can be connected with a main processor unit (MPU) using a single cable connection and power supplied via the MPU.



IPX7 water protection

Daylight Viewable Display

The 12.1 inch size MFD provides 800x600 pixels resolution. The 900cd/m² high brightness, color LCD with anti-reflecting surface coating glass offers bright, vivid indication in detail even in under direct sunlight. The color palette is selectable for day and night mode.



Anti-reflective surface

Simple Operation

The MarineCommander offers a simple graphical user interface and intuitive operation with minimum buttons and rotary knob. The display layout can be split into up to 4 panes and easily customized layout with a simple operation.

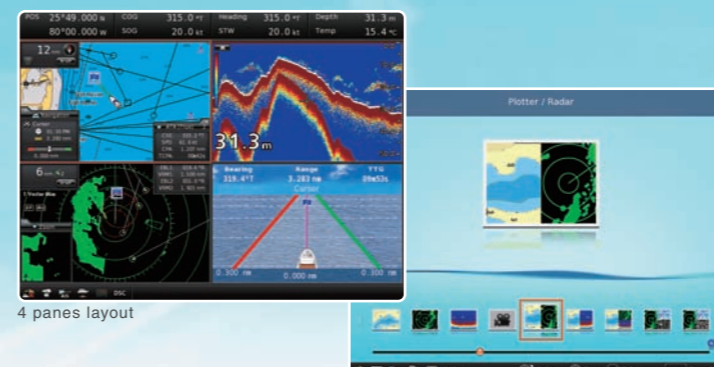

4 panes layout

Layout select menu

MXG-5000 GPS Receiver

The MXG-5000 is a 12 channel GPS receiver with WAAS, EGNOS and MSAS differential corrections. It offers better accurate position information enclosed in the IPX6 high-pressure water jet resistance.



GPS Receiver
MXG-5000

USB Flash Drive Connection

The MFD has a USB slot to connect with a USB flash drive. Waypoint, track and route information and memo data can be backed up to a USB flash and imported to other MarineCommanders or a PC.

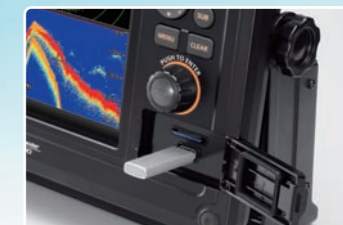

SD card slot (above) and USB slot

* To guarantee the waterproof protection, the front panel cover must be closed.

• Marine Radar

The MXR-5000R/T marine radar provides clear target discrimination. Waypoint and AIS target can be overlaid on the radar screen. The marine radar helps collision avoidance and increases your safety at sea. The radar images can be overlaid on the plotter screen in the same scale and helps you to detect dangerous objects.

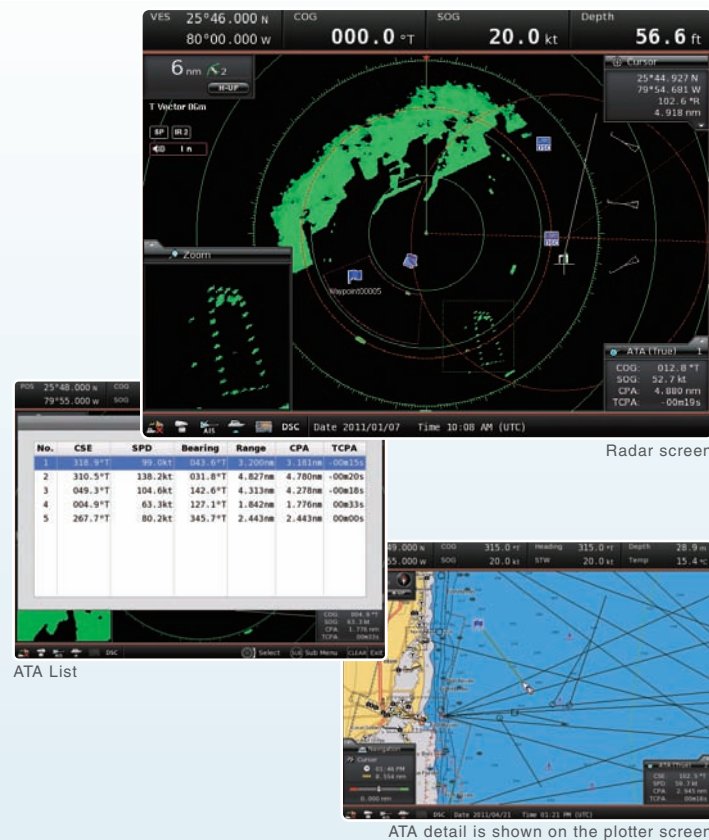

Simplified ATA (Automatic Tracking Aid)

The simplified ATA function allows you to plot up to 10 targets and the radar continues to track the targets automatically. The ATA targets can be overlaid on the plotter screen.

Marine Radar

MXR-5000T

4kW, 4 feet (120cm) open array scanner
Up to 48NM observation
48 rpm high rotation speed



or

MXR-5000R

4kW, 2 feet (60cm) radome scanner
Up to 36NM observation
48 rpm high rotation speed



• Fish Finder

When connected a fish finder module, the MarineCommander system can have a dual frequency sounder function. Using the 50kHz/200kHz dual frequency mode, the MarineCommander enhances the separation and helps in fish detection.

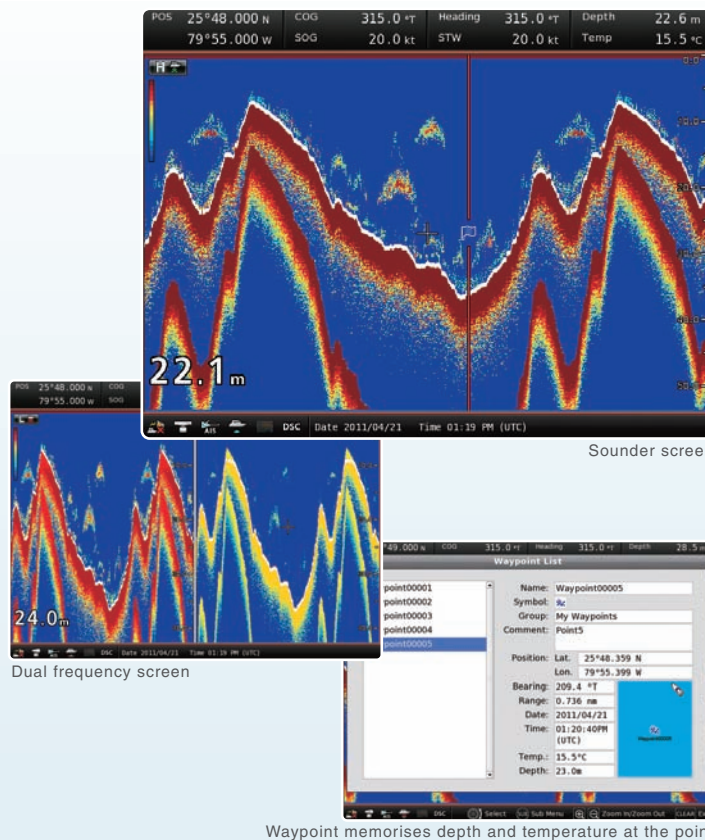

Waypoint on the fish finder

When used with the fish finder module, the MarineCommander memorises the waypoint information with depth and temperature data.

Fish Finder

EX-3193

600W transom transducer
Depth, speed and temperature in one housing
50kHz and 200kHz dual frequency



or

EX-3194

600W thru-hull transducer
Depth, speed and temperature in one housing
50kHz and 200kHz dual frequency



or

EX-3195

1kW thru-hull transducer
Depth and fast-response water-temperature sensor
50kHz and 200kHz dual frequency



• AIS and VHF Transceiver

AIS (Automatic Identification System) receives real-time vessel traffic information broadcasted by other AIS equipped vessels. Using the optional MA-500TR or MXA-5000, the AIS data can be overlaid on the plotter and radar screen.

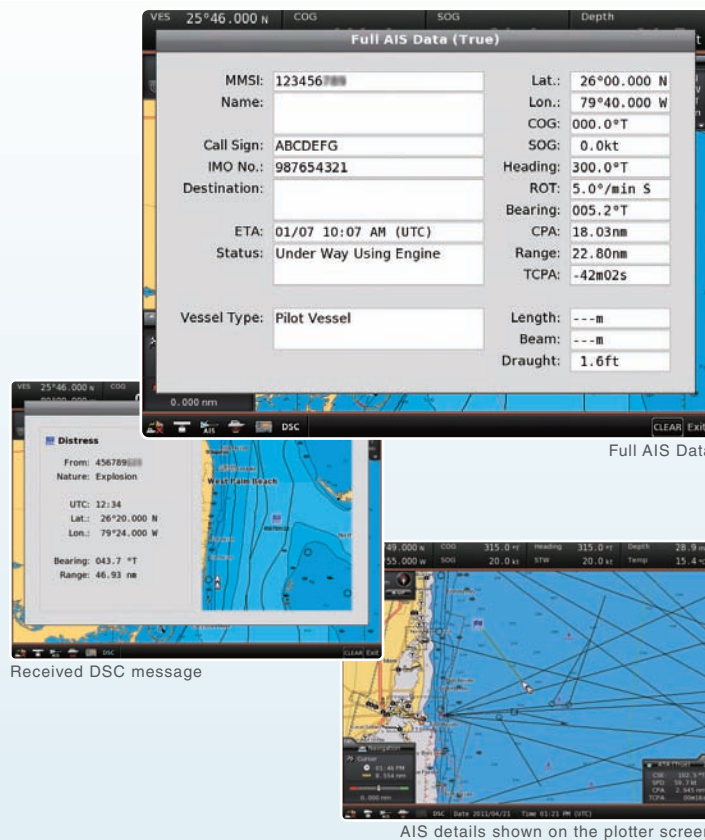

DSC call (VHF transceiver required)

The MarineCommander has the capability to be connected to compatible Icom VHF transceivers.* Various types of DSC calls, including individual, group, all ship, position and polling request*, can be initiated from the MarineCommander. Received DSC messages and position information can be shown on the plotter display.

*IC-M604/M603 firmware upgrade version, IC-M504/M505 compatible version or IC-M412 is required.
Type of transmitting DSC calls are depending on the connected VHF transceiver's capability.

AIS & VHF Transceivers



• Engine Monitoring

When connected to engine/environment/positioning sensors with an NMEA 2000 interface, the MarineCommander shows current data on a virtual engine meter. These data also can be shown on the status-bar or data-bar according to your setting.



Graphic screens

• Video Camera Monitoring

The MarineCommander has four video input ports with RCA connectors for connecting up to 4 surveillance video cameras (NTSC or PAL format) and allows you to monitor surroundings and crew members on the MarineCommander display.



• Other Features

- The external display connector (analog RGB) allows you to output to an external display
- Multiple language display (English/French/Spanish)
- External NMEA2000 Connection (Engine, Fuel, Engine Temperature, Wind, GPS, Compass, STW)
- Memo function allows you to store a comment with picture data* and position information.

* To show a picture data, the picture data must be stored in the connected USB flash drive.

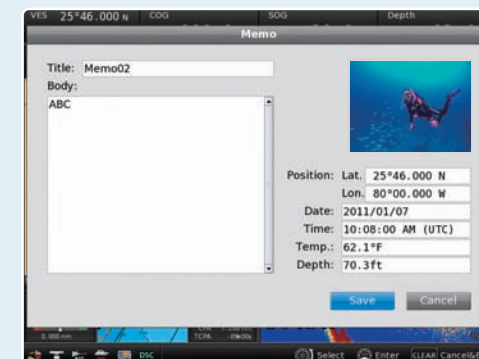

Specifications

Unit:mm (inch)

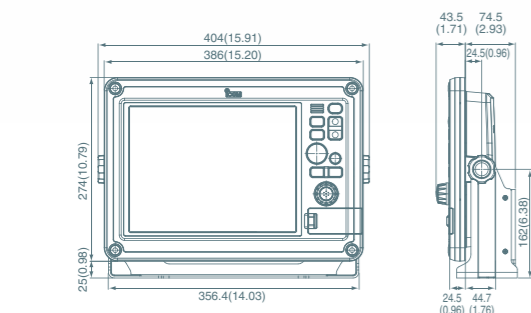

Multi-function display

MXD-5000	
Multi-function display	12.1 inch TFT
Screen size	246x184.5 mm
Screen resolution	SVGA 800x600 dots
Screen brightness	900 cd/m ² (Max.)
Contrast ratio	500
Viewing angle (Contrast ratio ≥10)	Vertical: Top 50° to Bottom 70° Horizontal: Left 70° to Right 70°
Power supply	30V DC (Supplied from MXP-5000)
Dimensions (W×H×D) (Projections not included)	386×274×69.2 mm; 15.2×10.79×2.72 in (without bracket) 404×299×102 mm; 15.91×11.77×4.02 in (with bracket)
Weight (approx.)	3.6kg; 7.9lb (without bracket) 4.1kg; 9.0lb (with bracket)
Usable temperature range	-20°C to +60°C; -4°F to +140°F
Waterproofing	IPX7
Cable length	5m; 16.4ft
Optional extension cable	EX-3187 (5m; 16.4ft)

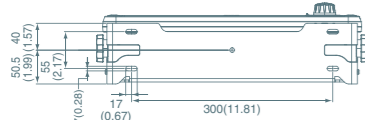

Main processor unit

MXP-5000	
Power supply	12/24V DC (10.8 to 31.2V DC)
Current drain(at 12V DC) (at Maximum brightness)	Less than 4.7A (One MXD-5000) Less than 7.7A (Two MXD-5000s)
Dimensions (W×H×D) (Projections not included)	360×88×228.8mm; 14.17×3.46×9.01 in
Weight (approx.)	4.25kg; 9.37lb
Usable temperature range	-20°C to +60°C; -4°F to +140°F
Waterproofing	IPX4

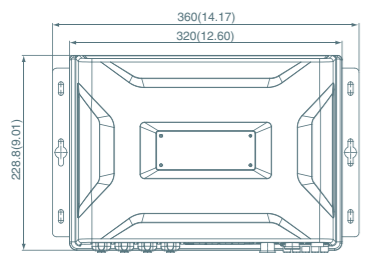

Fish Finder

MXF-5000	
Power supply	12/24V DC (10.8 to 31.2V DC)
Current drain (at 12V DC)	Less than 0.6A (Water depth range: 40m, output power 600W) Less than 1.0A (Water depth range: 40m, output power 1kW)
Output power	600W/1KW
Transmission frequency	50kHz ±1kHz 200kHz ±1kHz
Dimensions (W×H×D) (Projections not included)	250×67×200 mm; 9.84×2.64×7.87 in
Weight (approx.)	2.18kg; 4.8lb
Usable temperature range	-20°C to +60°C; -4°F to +140°F
Waterproofing	IPX4
Optional data cable	OPC-1895 (20m; 65.6ft)

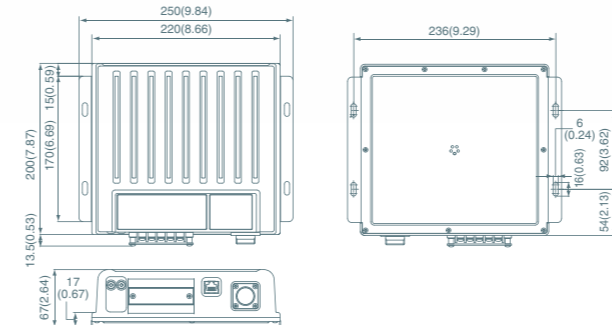

Radar Units

	MXR-5000R	MXR-5000T
Power supply	12/24V DC (10.8 to 31.2V DC)	12/24V DC (10.8 to 31.2V DC)
Current drain (at 12V DC)	Less than 5.0A	Less than 5.5A
Dimensions (W×H×D) (Projections not included)	250×67×200 mm; 9.84×2.64×7.87 in	250×67×200 mm; 9.84×2.64×7.87 in
Weight (approx.)	2.1kg; 4.6lb	2.1kg; 4.6lb
Usable temperature range	-20°C to +60°C; -4°F to +140°F	-20°C to +60°C; -4°F to +140°F
Waterproofing	IPX4	IPX4
Optional data cable	OPC-1895 (20m; 65.6ft)	OPC-1895 (20m; 65.6ft)

Complies with the limits for a Class A digital device, pursuant to Part 15 of the FCC Rules.

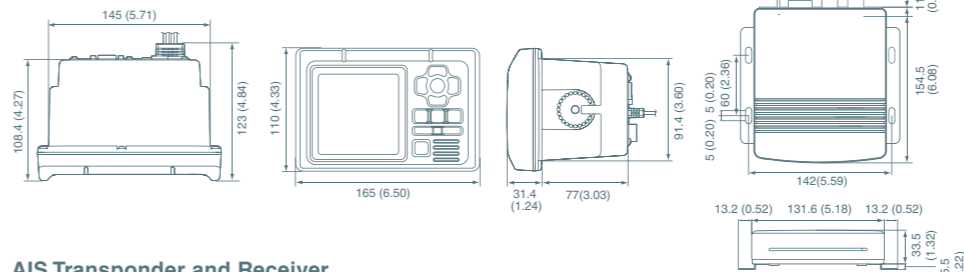

AIS Transponder and Receiver

	MA-500TR	MXA-5000
Frequency range (Unit:MHz)	161.975, 162.025 (default) 156.025-162.025	Rx: 161.975, 162.025 Simultaneous reception
Type of emission	16K0G3E (GMSK)	16K0F1D (GMSK)
Power supply requirement	12.0V DC (9.6-15.6V)	12.0V DC (10.8-15.6V)
Dimensions (Projections not included; WxHxD)	165×110×123 mm; 6.5×4.33×4.84 in	132×34×155 mm; 5.2×1.34×6.1 in
Weight (approx.)	1000g; 2.2lb	460g; 1.0lb
Current drain	Transmit: 1.5A Receive: 0.7A	0.25A
Sensitivity	-110dBm	-116dBm typ.
Intermodulation rejection	65dB	65dB
RF output power	2W	-
Waterproofing	IPX7 (1m depth/30 min)**	-
Data interface	IEC 61162-1:2000 or IEC 61162-2 selectable	Input: IEC 61162-1:2000 Output: IEC 61162-2

Measurements made in accordance with IEC 62287-1. ** Main unit only.

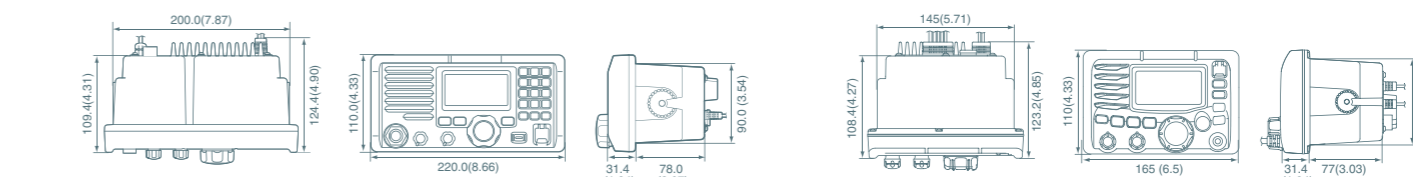

VHF Marine Transceivers

	IC-M604 (USA)	IC-M603 (EURO)	IC-M504 (USA)	IC-M505 (EURO)
Frequency range (Unit:MHz)	TX: 156.025-157.425 RX: 156.050-163.275	TX: 156.000-161.450 RX: 156.000-163.425	TX: 156.025-157.425 RX: 156.050-163.275	TX: 156.000-161.450 RX: 156.000-163.425
Type of emission	16K0G3E, 16K0G2B		16K0G3E, 16K0G2B	
Power supply requirement	13.8V DC ±15%		13.8V DC ±15%	
Dimensions (Projections not included; WxHxD)	220x110x109.4 mm; 8.66×4.33×4.31 in		165x110x123.2 mm; 6.5×4.33×4.85 in	
Weight (approx.)	1400g; 3.1lb		1450g; 3.2lb	
Current drain	Transmit: 5.5A Receive: 1.5A		Transmit: 5.5A Receive: 1.5A	
Sensitivity	0.22µV typ. (12dB SINAD)		0.22µV typ. (12dB SINAD)	
Intermodulation rejection	80dB		75dB	
Audio output power (10% dist./4Ω load)	5W typical		2W	
RF output power	25W/1W		25W/1W	
Waterproofing	IPX7 (1m depth/30 min)		IPX8 (1.5m depth/30 min)	

Measurements made in accordance with TIA/EIA 603 or EN 301 025.

All stated specifications are subject to change without notice or obligation.

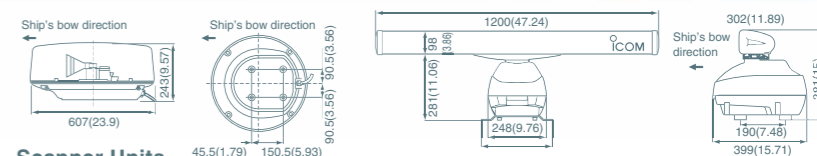

Scanner Units

	MXR-5000R Radome scanner	MXR-5000T Open array scanner
Type	2ft (60cm) radome	4ft (120cm) open array
Peak output power	4kW	4kW
Maximum range	36NM	48NM
Rotation speed	24 rpm, 36 rpm, 48 rpm	24 rpm, 36 rpm, 48 rpm
Beam width	Horizontal: 4°typ. Vertical: 22°typ.	2°typ. 25°typ.
Side lobe	-18dB	-24dB
Polarization	Horizontal	Horizontal
Transmission frequency	9410MHz±30MHz PON	9410MHz±30MHz PON
Pulse width	80ns/2880Hz, 80ns/2160Hz, 250ns/2160Hz, 350ns/2160Hz, 900ns/720Hz	80ns/2880Hz, 80ns/2160Hz, 250ns/2160Hz, 350ns/2160Hz, 900ns/720Hz
Dimensions	607 (Diameter)×243 (H) mm; 23.9×9.57 in	1205 (Diameter of rotation)×381 (H) mm; 23.9×15 in
Weight (approx.)	8kg; 17.6lb (without cable)	17kg; 37.4lb (without cable)
Usable temperature range	-25°C to +70°C; -13°F to +158°F	-25°C to +70°C; -13°F to +158°F
Relative humidity	Less than 95% at 40°C	Less than 95% at 40°C
Waterproofing	IPX6	IPX6
Supplied system cable	OPC-1188A (15m; 49.2ft)	OPC-1189A (20m; 65.6ft)
Optional radar system cables	OPC-1077A (20m; 65.6ft) OPC-1078A (30m; 98.4ft)	OPC-1078A (30m; 98.4ft)



Transducer

	EX-3193	EX-3194	EX-3195
Type	600W transom type, built-in boat speed and temperature sensors	600W thru-hull type, built-in boat speed and temperature sensors	1kW thru-hull type, built-in temperature sensors
Output power	600W	600W	1kW
Operating frequency	50kHz, 200kHz	50kHz, 200kHz	50kHz, 200kHz
Beamwidth	50kHz: 45°, 200kHz: 11°	50kHz: 45°, 200kHz: 11°	50kHz: 15°×21°, 200kHz: 3°×5°
Vessel speed sensor	18,000 p/nm	19,000 p/nm (with fairing) 21,500 p/nm (without fairing)	-
Speed range	1kt-44kt	1kt-44kt	-
Weight (approx.)	0.5kg; 1.1lb	2.5kg; 5.5lb	3.6kg; 7.9lb
Optional transducer ext. cable	OPC-1929 (6m; 19.7ft)	OPC-1929 (6m; 19.7ft)	OPC-1929 (6m; 19.7ft)